

XLC260 **Lattice Crawler Crane**

XLC260



XCMG GROUP





CONTENTS

P02	<ul style="list-style-type: none">• Product introduction• Safety Devices• Main parameters
P11	<ul style="list-style-type: none">• Heavy boom working condition• Tower jib working condition
P39	<ul style="list-style-type: none">• Transport parameters of main components

02

XLC260 CRAWLER CRANE

P03–P06 Product introduction

P07–P08 Safety Devices

P09–P10 Main parameters

Product introduction

Boom combination

The boom sections of XLC260 crawler crane use high-strength seamless pipe (large cross section, thick wall and large diameter) as the chords and lacing tubes, supplemented by four-chord lattice structure which is welded by high strength steel plate, with equal section in the middle and variable section at two ends. When the crane is configured with all working conditions, boom system includes boom butt 1 × 9m, boom transition section 1 × 6m, boom top 1 × 5m, tower jib butt 1 × 1.5m, tower jib transition section 1 × 4.5m, tower jib top 1 × 3m, front strut 1 × 7.5m, rear strut 1 × 7.5m, single top unit, 3m insert section (1 × 3mA, 1 × 3mB and 1 × 3mC), 6m insert section (1 × 6mA, 1 × 6mB and 1 × 6mC), 12m insert section (2 × 12mA, 2 × 12mB and 2 × 12mC).

In boom working condition, the maximum lifting capacity is 260t@5.5m (parts of line 24), the maximum load moment is 260t × 5.5m = 1430t.m. Boom length 23m~86m, boom composition: boom butt 1 × 9m, boom transition section 1 × 6m, boom top 1 × 5m, boom insert 1 × 3mA and 1 × 3mB, boom insert 1 × 6mA and 1 × 6mB, boom insert 2 × 12mA and 2 × 12mB. Main boom is optionally configured with single top unit.

In tower jib working condition, the maximum lifting capacity is 100t@10m (parts of line 10). Tower jib length 18m ~ 63m, tower jib composition: jib butt 1 × 1.5m, jib transition section 1 × 4.5m, jib top 1 × 3m, jib insert 1 × 3mB and 1 × 3mC, jib insert 1 × 6mB and 1 × 6mC, jib insert 1 × 12mB and 2 × 12mC, front strut 1 × 7.5m, rear strut 1 × 7.5m. Tower jib is optionally configured with tower jib single top.

Light boom length 25.5m ~ 97.5m, light boom is the combination of boom sections and tower jib sections.

Boom combination

In fixed jib working condition, the maximum lifting capacity is 100t@8m (parts of line 10). Fixed jib length 9m ~ 30m, composition: jib butt 1 × 1.5m, jib transition section 1 × 4.5m, jib top 1 × 3m, jib insert 1 × 3mB and 1 × 3mC, jib insert 1 × 6mB and 1 × 6mC, jib insert 1 × 12mB, strut 1 × 7.5m. Among which, 9m fixed jib can be used with 23m and 26m main boom to compose TBM working condition. In TBM working condition, when main hook or aux. hook is used separately, the maximum lifting capacity of main hook is 225.7t, the maximum lifting capacity of aux. hook is 100t; when main hook and aux. hook are used at the same time alternatively, the maximum lifting capacity is 170t.

Boom luffing components

Boom luffing component is made of high-strength pendant structure, with high safety factor. Pendant transition adopts balance beam structure with uniform stress; single pendant is equipped with “peach” -shaped connecting hole, the assembly is convenient, labor-saving and efficient.

Mast

Mast is a box-type two-limb structure, with strengthened beam between two limbs for good stability. Mast raising cylinder can rotate around connection pivot of turntable, to realize mast erection, raising and lowering.

Turntable

Turntable is a key load bearing structural component to connect crane superstructure and crane undercarriage, use of high-strength steel plate welded in “工” box-type composite box beam structure on both sides, coupled with undercarriage through slewing ring, with good overall strength and stability. Cab, main luffing winch, engine system, hydraulic pumps, hydraulic valves, electrical cabinet, mast, boom butt, superstructure counterweight and the self-assembly cylinder are respectively connected with different parts of the turntable.

Mechanism composition

Crane mechanism and configuration refer to the table below:

No.	Name	Application	Location
1	Main hoist winch	Used for main winch in heavy boom, boom single top, fixed jib (include TBM), tower jib, tower jib single top and light boom working conditions.	On boom butt, near the root position
2	Auxiliary hoist winch	(1) Used for aux. hook in boom single top and fixed jib (include TBM) working conditions; (2) Used as tower jib luffing winch in tower jib (include tower jib single top) working condition	On boom butt, near the top position
3	Single top winch (optional)	Used for aux. hook in tower jib single top working condition	Front side of turntable
4	Main luffing winch	Boom luffing	Middle part of turntable
5	Slewing unit	Superstructure slewing	Front side of turntable
6	Travel unit	Crane travel	Crawler drive sprocket

Hoist winch

Hoist winch includes main hoist winch, aux. hoist winch and single top winch (optional), planetary reducer is driven by motor, to achieve main or auxiliary hook block hoisting up/down through drum, guide pulley and hoist sheave block.

Hoist winch

The hoist winch has built-in planetary reducer, with constant closed brake, to achieve “spring braking/hydraulic release” function, safe and reliable. Ductile iron drum is used for the hoist winches with good vibration absorption. Double-line rope groove ensures that there is no messy rope when it is reeved in multiple layers, which effectively prolong the rope’s service life. The anti-rotation wire rope used for the winches has the features of independent steel core, high breaking force and high extrusion resistance, rated single line pull is 13.5t, rope diameter is ϕ 26 mm, the rope lengths for main hoist winch, aux. hoist winch and single top winch are 620m, 455m and 250m respectively.

Luffing winch

Luffing winch includes main luffing winch and tower jib luffing winch. Main luffing winch is independently driven by a double drum, and it is installed in the middle of turntable through pin shaft. For main luffing winch, planetary reducer is driven by motor to achieve boom luffing through drum and luffing pulley block. Main luffing winch has built-in planetary reducer, with constant closed brake, to achieve “spring braking/hydraulic release” function, safe and reliable. Main luffing winch drum has a ratchet pawl locking device, and driven by a hydraulic cylinder, to achieve multi-lock protection. Ductile iron drum is used for boom luffing winch with good vibration absorption. Double-line rope groove ensures that there is no messy rope when it is reeved in multiple layers, which effectively prolong the rope’s service life. Wire rope used for main luffing winch is with high breaking force, rated single line pull is 13.5t, rope diameter ϕ 26mm, rope length 360m. Tower jib luffing system shares with aux. hoist system, it is installed on boom butt and realize tower jib luffing through the changeover of the function.

Product introduction

Slewing unit

Slewing unit and slewing ring is driven by external meshing of gear, arranged in front of turntable, a planetary reducer is driven by motor to drive the slewing ring to achieve 360° rotation. Slewing unit has a built-in planetary reducer, with constant closed brake design to achieve “spring braking/hydraulic release” function, to ensure the slewing mechanism a high safety brake. Slewing unit also has a mechanical locking device for locking protection of the slewing unit. Slewing unit also has a free-swing function.

Slewing ring

Double-row ball slewing ring with elliptical track, it has the features of high strength, large bearing capacity, high precision, long service life and easy maintenance.

Cylinder assy

The connection of boom and turntable, car-body and track frame, counterweight tray and turntable, is realized by power pinning driven by cylinder. Mast raising cylinder, outrigger cylinder, crawler tension cylinder, all these allow the machine assembly/disassembly quicker and easier. Operator's cab also has a cylinder for vertical tilting and horizontal rotation.

Operator's cab

The new generation of 1.25m wide cab, it is bright with gorgeous appearance and wide vision, the operation of the cab is comfortable and convenient.

Car-body

Car-body is a box-type radial structure, welded by high strength steel plates with good overall rigidity and high strength.

Crawler travel unit

Crawler travel unit is divided into left/right crawler, consisting track frame, track shoe, track roller, drive sprocket, guide roller, carrier roller, travel device and tension device. Track frame: symmetrically arranged, one for each side, made of high-strength steel plate welded in box-type structure, and a parallel iron is set for car-body installation positioning to play a role of guide and wear. Drive roller: Drive roller assy. is connected on planetary reducer housing with high-strength bolts. Track roller: double-flange design, with built-in floating seals, self-lubrication. Tension roller: The rollers are used to adjust crawler tension level through hydraulic cylinder and adjusting pads. Carrier roller: The rollers have built-in floating seals, self lubrication. Track shoe: installed on crawler tracks. Travel unit: constant closed planetary gear reducer with strong travel power and high flexibility and mobility. It is multiple wet-type constant closed brake, spring brake, and hydraulic release.

Hydraulic system

Adopt LUDV load sensing system controlled by hydraulic pilot proportional control, with accurate speed, sensitive operation and good fine motion performance. Main valve can achieve the synchronous operation of multiple movements, compact in structure and easy for maintenance. Specialized slewing closed system design, with stable start and stop, good fine motion performance and proportional characteristics, meeting the requirements of fine lifting operation.

Electrical system

Electrical system mainly includes the following components: engine control, auxiliary equipment, hydraulic system control, load moment limiter, safety monitors and data display. Electrical system composition: conventional electrical system and PLC control system. Conventional electrical system includes power supply, start control, cab air conditioner and sound, lights, wipers and so on. PLC control system includes control of main and auxiliary winches, slewing, boom luffing and other movements, engine state monitoring. All the movements are controlled through PLC logic control of CAN-bus technology.

Engine system

Model: Shanghai Diesel engine SC9DF330G3;
Type: six-cylinder in line, water-cooled, turbocharged, inter-cooled, electric injection four-stroke diesel engine;
Environmental protection: comply with off-road China III and standards;
Rated power: 243kw/2000rpm;
Maximum output torque: 1425N.m;
Fuel tank capacity: 600L.

Counterweight

Counterweight consists of car-body counterweight and turntable counterweight. Car-body counterweight is total 30t and uses mast derrick to realize the self-assembly, car-body counterweight is installed at front and rear of track frame. Its composition is as follows: car-body counterweight 2 × 15t. Turntable counterweight has three options of 85t, 75t and 65t. Independent load chart based on different counterweight combinations are provided to meet different lifting requirements, so that customers can use the working conditions more practical, economical, convenient and fast. In addition, the optional use of counterweight can also lower the cost for customers when transporting and buying the crane.

Hook block

Hook block configuration is as the follows:

Hook name	160T	13.5T	200T (option)	260T (option)
Weight (t)	2.2	0.5	4.2	4.6
Qty.	1	1	1	1
Number of pulleys	7	0	7	9

Safety Devices

This crane widely uses mechanical, electronic and hydraulic and other safety and warning devices to ensure the safe use of the machine. The safety devices include: load moment limiter, slewing lock device, boom backstop device, hoist limit switch, boom angle limit device, anemometer, level gauge, camera, slewing warning, travel warning and hydraulic system relief valve, balance valve, hydraulic lock, and etc.

Assembly mode & Working mode exchange switch

Exchange between assembly mode and working mode is realized. In Assembly mode, over-wind protection device, boom angle limiter and load moment limiter are all out of service, in order to facilitate crane assembly. In working mode, all safety devices do work.

Emergency stop button

In emergency conditions, press this button to stop all crane movements.

Anti-operation error function

The handle is to prevent mis-operation. There is a safety protection switch on the handle, all movement signals are shielded when this switch is not pressed, and the handle is disabled to prevent operation error.

Winch over-wind protection device

There is an over-wind device on boom head to prevent rope from being over-wound. When main/auxiliary winch hoists up to a certain lifting height, the over-wound warning lamp on instrument panel lights up, at the same time, load moment limiter stops crane hoisting up movements.

Winch over-release protection device

An encoder is set on hoist winches as rope end limiter to prevent wire rope from over-releasing. When there are only three loops of rope left, the over-release warning lamp on instrument panel lights up, at the same time, the movement of lowering down is stopped.

Ratchet locking device

It is used to lock the luffing winch so that boom is stopped and placed safely at non-working state.

Slewing locking device

Slewing locking device is used for superstructure slewing locking when stopping the crane.

Backstop device

The crane is equipped with boom and jib strut backstop devices to prevent boom and strut backward tilting.

Boom angle limit

When boom is raised to a specified angle, the boom raising is stopped by both control of load moment limiter and hoist limit switch. When boom luffing angle is less than the specified angle, boom lowering is stopped by control of load moment limiter and which also gives a sound warning.

Hook latch

All hook blocks are equipped with hook latch to prevent the hanging rope on the hook head from falling.

Hydraulic system safety protection device

Hydraulic system is equipped with hydraulic balance valve, hydraulic relief valve and other devices to ensure the stable and safe work for the system.

LMI system

Detection function: LMI can automatically detect parameters such as boom angle and lifting weight. Display function: use large-screen color LCD display (10.4 inches) to show important parameters in lifting operation through text (Chinese and English) and graphics, such as load moment percentage, actual lifting weight, rated lifting weight, radius, boom length, angle, maximum lifting height, working condition code, parts of line, limit angle and error code. Warning function: with complete pre-alarm and overload stop function. If it is detected that the actual weight exceeds the rated lifting capacity or boom angle exceeds the maximum value, LMI will send alarm and limit the current movement of the crane. The system has self-diagnosis function.

Audio/video warning

The tri-color light and audio/video warning can show crane loading and operation state to give the operator and staff outside warning.

Illuminator lamp

The illuminator lamp is in front of turntable, on the top of and inside operator's cab for lighting.

Rearview mirror

It is located outside the operator's cab for the driver easy to observe the situation behind the machine.

Height mark lamp

It is located on boom tip for high level operation warning.

Anemometer

It can detect the current wind speed and send signal to the monitor in operator's cab to remind the operator for safe operation in wind load.

Level gauge

This crane is equipped with electronic and mechanical level gauges, which can display the ground gradient, so as to provide crane levelness for the operator.

Monitoring system

The monitoring system is composed of four cameras and one monitor. This system is used to monitor the rope arrangement on main winch, aux. winch and luffing winch, as well as the safety condition at rear of the crane and the lifting condition on boom head.

Main parameters

Outline Dimensions

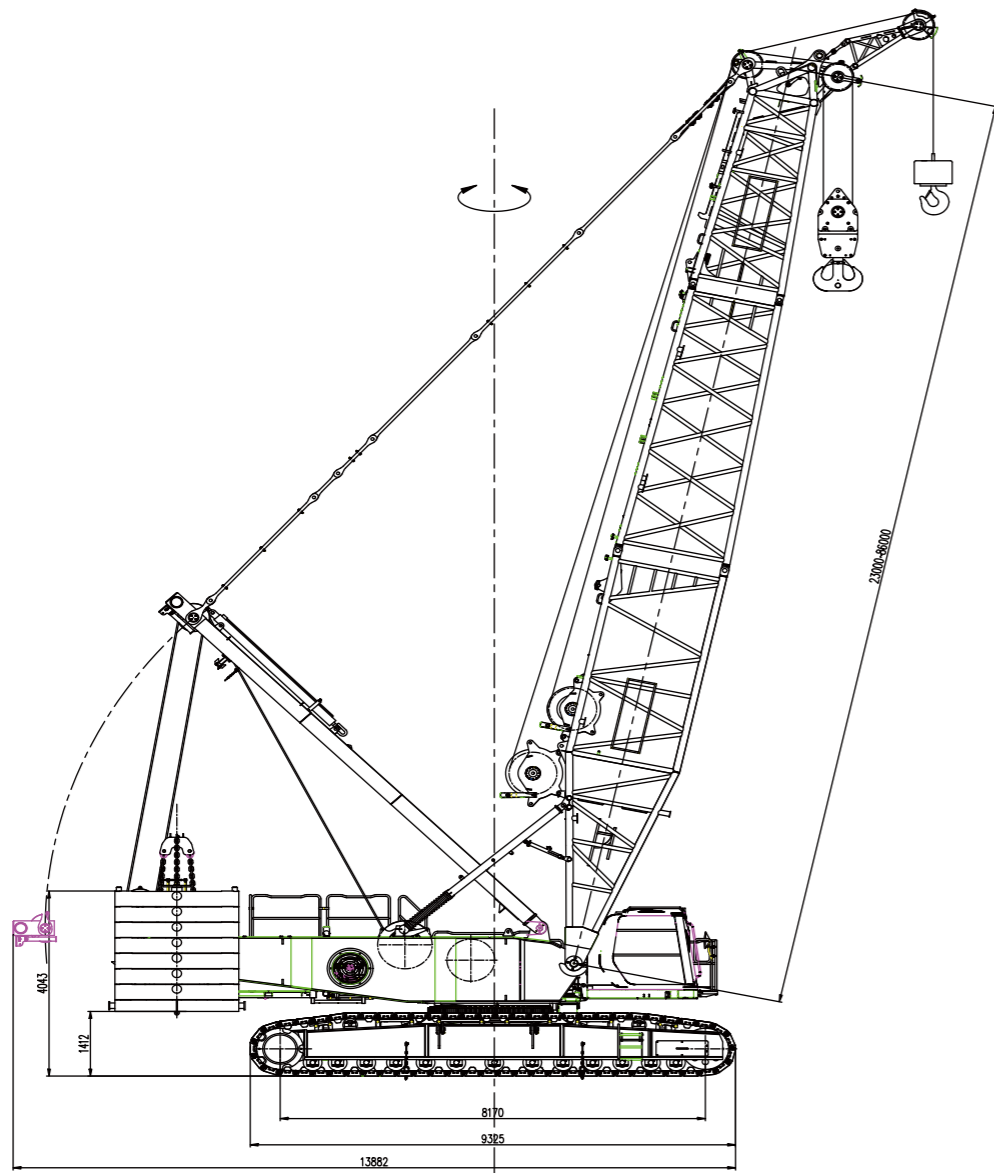

Remove boom, mast and etc.

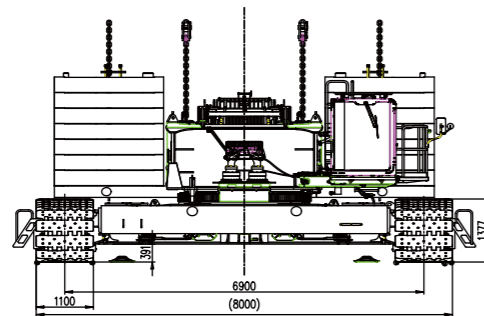

XLC260 crawler crane outline dimension

Technical Parameters

Item	Unit	Data	
Max. rated lifting capacity	Boom working condition	t	260
	Tower jib working condition	t	100
	Fixed jib working condition	t	100
Max. load moment	t.m	1430	
Dimensions	Boom length	m	23~86
	Tower jib length (optional)	m	18~63
	Fixed jib length (optional)	m	9~30
Speed	Hoist winch max. single line speed	m/min	130
	Boom luffing winch max. single line speed	m/min	2×47
	Tower jib luffing winch max. single line speed	m/min	130
	Max. slewing speed	rpm	1.0
Engine	Max. travel speed	km/h	1.0
	Rated power	kW	243
	Emission standard	-	Non-road China III
Total mass (23m boom, 260t hook block)		t	224.7
Mean ground pressure		MPa	0.12
Grade-ability		-	30%
Max. mass of single unit in transport state		t	35.4
Max. dimension of single unit in transport state (L × W × H)		m	10.7 × 3.0 × 3.3

Note:

1. Single line speed is the calculated value of the rope on the drum most outside layer with engine idle running, which changes according to different load and working conditions.
2. Travel speed and slewing speed is the theoretical value for the crane based on level and solid ground.
3. The data in this table is full boom configuration based on 85t turntable counterweight and 30t car-body counterweight.
4. We reserve the right to improve and update the technical specifications without prior notice.

11

XLC260 CRAWLER CRANE

P12-P24 Heavy boom working condition

1.1 Boom working condition _ boom main hook (without boom single top, HB/1)

1.2 Boom working condition _ boom main hook (with boom single top aux. hook, HBS/1)

1.3 Boom working condition _ boom single top aux. hook (with boom main hook, HBS/2)

P25-P38 Tower jib working condition

2.1 Working radius of tower jib working condition (HW)

2.2 Partial lifting performance of tower jib working condition (HW)

1.1 Boom working condition _ boom main hook (without boom single top, HB/1)

Boom working condition _ boom main hook working range (without boom single top, HB/1)

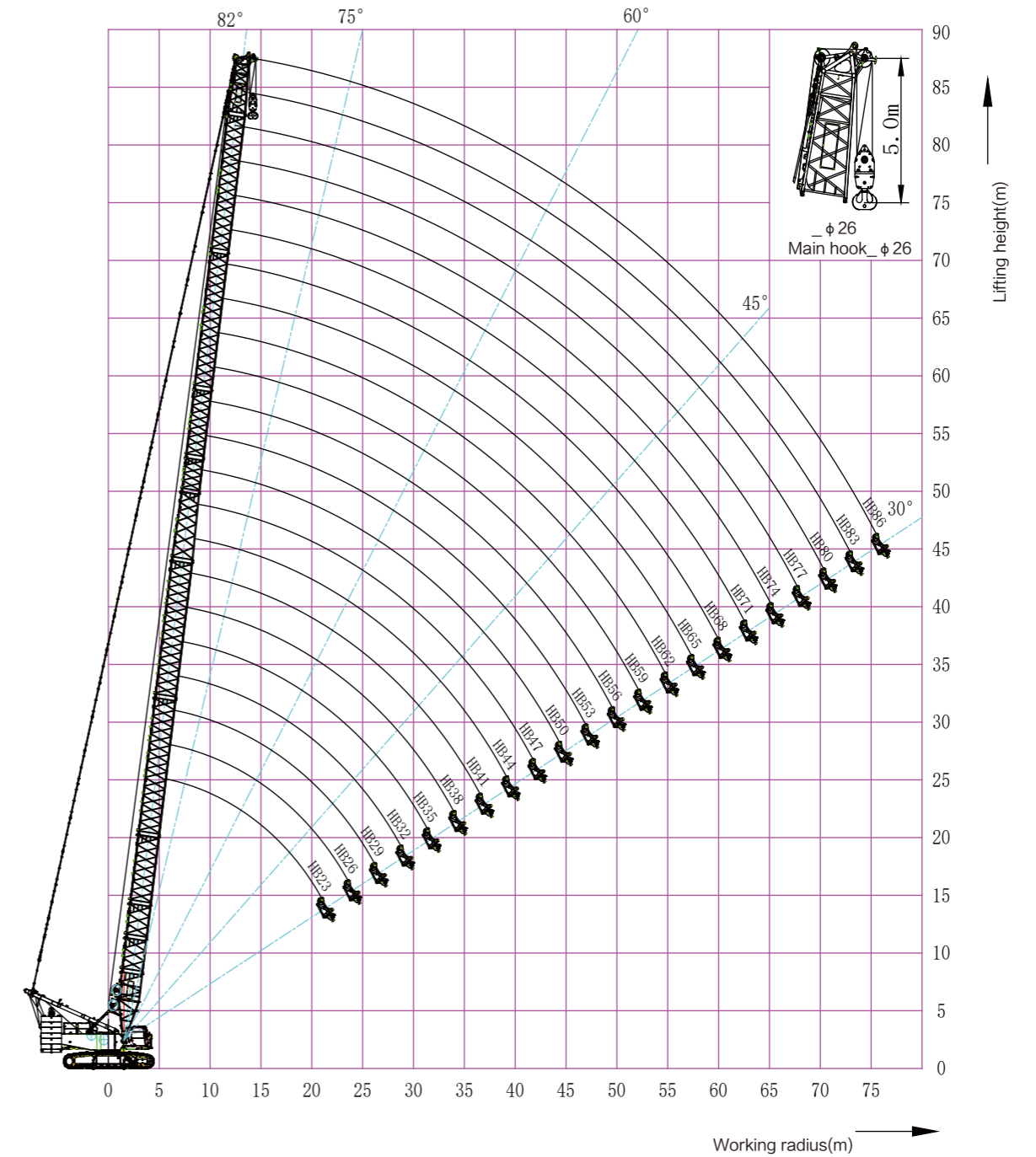

Boom working condition _ boom main hook working range (without boom single top, HB/1)

Typical Working Conditions

1.1 Boom working condition _ boom main hook (without boom single top, HB/1)

Boom working condition _ boom main hook lifting capacity table (without boom single top, HB/1_85t+30t)

Working radius (m)	Boom length (m)										
	23	26	29	32	35	38	41	44	47	50	53
5.5	260										
6	230.9	230.9	215.9								
7	191.1	191.1	191	191	183.9	172.9					
8	162.7	162.7	162.6	162.6	162.4	162.3	161.7	150.4			
9	141.5	141.5	141.3	141.4	141.2	141	140.8	139.1	135.5	127.2	127.2
10	125	125	124.8	124.8	124.6	124.5	124.3	124.2	121.2	118.3	115.6
11	111.8	111.8	111.6	111.6	111.4	111.3	111	111	109.4	107	104.7
12	101	101	100.8	100.8	100.6	100.5	100.2	100.1	99.7	97.6	95.5
13	91.9	92	91.8	91.8	91.6	91.5	91.2	91.1	90.9	89.6	87.8
14	84.3	84.3	84.2	84.2	84	83.8	83.6	83.5	83.3	82.7	81.1
15	77.9	77.9	77.7	77.7	77.5	77.3	77.1	76.9	71.6	71.4	71.1
16	72.4	72.4	72.2	72.2	72	71.9	71.6	71.5	71.2	71	70.1
17	67	67.1	67.1	67.1	67	66.9	66.8	66.7	66.4	66.2	65.6
18	61.9	62	62	62	61.9	61.8	61.7	61.6	61.4	61.3	61.1
19	57.4	57.6	57.5	57.6	57.5	57.4	57.2	57.1	57	56.8	56.6
20	53.5	53.6	53.6	53.7	53.6	53.5	53.3	53.2	53	52.9	52.7
22		47.1	47	47.1	47	46.9	46.7	46.6	46.4	46.3	46.1
24		41.7	41.7	41.8	41.7	41.6	41.4	41.3	41.1	41	40.7
26			37.3	37.4	37.3	37.2	37	37	36.8	36.6	36.4
28				33.8	33.6	33.6	33.4	33.3	33.1	32.9	32.7
30					30.5	30.4	30.2	30.2	30	29.8	29.6
32					27.8	27.7	27.5	27.5	27.3	27.1	26.9
34						25.4	25.2	25.2	24.9	24.8	24.5
36							23.1	23.1	22.9	22.7	22.5
38								21.3	21.1	20.9	20.7
40								19.6	19.4	19.3	19
42									18	17.8	17.6
44										16.5	16.2
46											15
Parts of line	24	22	20	18	16	15	14	13	12	11	10

Note:

1.For areas with “**” , when boom length exceeds 74m, center hitch needs to be used; when boom length exceeds 77m, wedge needs to be used to assist boom raising.

1.1 Boom working condition _ boom main hook (without boom single top, HB/1)

Boom working condition _ boom main hook lifting capacity table (without boom single top, HB/1_85t+30t)

Working radius (m)	Boom length (m)										
	56	59	62	65	68	71	74	77*	80*	83*	86*
10	113.2	108.7	98.4								
11	102.7	100.6	97.5	88.6	79.4	71.6					
12	93.9	92	90.2	86.7	77.6	69.8	62.8	61.2	56		
13	86.4	84.7	83.1	81.5	76.4	68.7	61.8	60.4	55.3	50.8	46.6
14	79.9	78.4	76.8	75.4	74.1	67.5	60.7	59.5	54.6	50.1	46
15	71.3	71	70.8	70.2	68.9	66.5	59.7	58.7	53.8	49.4	45.4
16	69.3	68	66.8	65.6	64.4	63.4	58.7	58	53.1	48.8	44.8
17	64.8	63.7	62.6	61.5	60.4	59.4	57.7	57.2	52.4	48.1	44.2
18	60.9	59.8	58.8	57.8	56.7	55.9	54.9	54.1	51.7	47.5	43.6
19	56.8	56.3	55.4	54.4	53.5	52.7	51.7	51	50.1	46.9	43
20	52.8	52.6	52.3	51.4	50.5	49.7	48.9	48.2	47.4	46.2	42.5
22	46.2	46	45.8	45.6	45.3	44.7	43.9	43.3	42.5	41.9	41.1
24	40.9	40.7	40.5	40.3	40	39.9	39.6	39.2	38.4	37.8	37.1
26	36.5	36.3	36.1	35.9	35.6	35.5	35.3	35.2	34.9	34.4	33.7
28	32.9	32.6	32.4	32.2	31.9	31.8	31.6	31.5	31.3	31.1	30.7
30	29.7	29.5	29.3	29.1	28.8	28.7	28.4	28.4	28.1	28	27.7
32	27.1	26.8	26.6	26.4	26.1	26	25.7	25.7	25.4	25.4	25
34	24.7	24.5	24.3	24	23.8	23.6	23.4	23.3	23.1	22.9	22.6
36	22.7	22.4	22.2	22	21.7	21.6	21.3	21.3	21	20.8	20.6
38	20.9	20.6	20.4	20.1	19.9	19.7	19.5	19.4	19.2	19	18.7
40	19.2	19	18.8	18.5	18.3	18.1	17.9	17.8	17.5	17.4	17.1
42	17.8	17.5	17.3	17.1	16.8	16.7	16.4	16.4	16.1	15.9	15.6
44	16.5	16.2	16	15.7	15.5	15.3	15.1	15	14.8	14.6	14.3
46	15.3	15	14.8	14.5	14.3	14.2	13.9	13.8	13.6	13.4	13.1
48	14.2	13.9	13.7	13.5	13.2	13.1	12.8	12.8	12.5	12.3	12
50	13.2	12.9	12.7	12.5	12.2	12.1	11.8	11.8	11.5	11.3	11
52		12	11.8	11.5	11.3	11.2	10.9	10.8	10.6	10.4	10.1
54			10.9	10.7	10.4	10.3	10	10	9.7	9.6	9.3
56				9.9	9.7	9.5	9.3	9.2	8.9	8.8	8.5
58					9.2	8.9	8.8	8.5	8.2	8.1	7.8
60						8.2	8.1	7.9	7.8	7.5	7.1
62							7.5	7.2	7.2	6.9	6.5
64								6.6	6.6	6.3	5.9
66								6.1	6	5.8	5.3
68									5.5	5.3	4.8
70										4.8	4.3
72											4.1
74											3.4
76											3
Parts of line	9	9	8	7	7	6	5	5	5	4	4

Note:

1.For areas with “**” , when boom length exceeds 74m, center hitch needs to be used; when boom length exceeds 77m, wedge needs to be used to assist boom raising.

Typical Working Conditions

1.1 Boom working condition _ boom main hook (without boom single top, HB/1)

Boom working condition _ boom main hook lifting capacity table (without boom single top, HB/1_75t+30t)

Working radius (m)	Boom length (m)										
	23	26	29	32	35	38	41	44	47	50	53
5.5	244.6										
6	219.4	219.4	215.9								
7	181.5	181.5	181.4	181.4	181.3	172.9					
8	154.5	154.6	154.4	154.4	154.2	154.1	150.3	145.9			
9	134.3	134.3	134.2	134.2	134	133.9	132	128.5	125.1	121.9	118.8
10	118.6	118.6	118.4	118.5	118.3	118.1	117.4	114.6	111.8	109.1	106.6
11	106	106	105.9	105.9	105.7	105.6	105.3	103.2	100.9	98.6	96.5
12	95.8	95.8	95.6	95.6	95.4	95.3	95	93.8	91.8	89.9	88
13	87.2	87.2	87	87.1	86.8	86.7	86.4	85.9	84.1	82.4	80.8
14	80.2	80.2	80	80.1	79.8	79.7	79.4	79.1	77.5	76	74.5
15	73.5	73.6	73.6	73.7	73.6	73.5	73.4	73.2	71.8	70.5	69.1
16	67.1	67.2	67.2	67.3	67.2	67.1	66.9	66.9	66.7	65.6	64.4
17	61.6	61.8	61.7	61.8	61.7	61.6	61.4	61.4	61.2	61	60.2
18	56.9	57	57	57.1	56.9	56.8	56.7	56.6	56.4	56.3	56.1
19	52.7	52.9	52.8	52.9	52.8	52.7	52.5	52.5	52.3	52.1	51.9
20	49.1	49.3	49.2	49.3	49.2	49.1	48.9	48.8	48.6	48.5	48.3
22		43.1	43.1	43.2	43.1	43	42.8	42.7	42.5	42.4	42.2
24		38.2	38.2	38.3	38.1	38.1	37.9	37.8	37.6	37.4	37.2
26			34.1	34.2	34.1	34	33.8	33.7	33.5	33.4	33.1
28				30.8	30.7	30.6	30.4	30.3	30.1	30	29.7
30					27.8	27.7	27.5	27.5	27.2	27.1	26.8
32					25.2	25.2	25	25	24.7	24.6	24.3
34						23	22.8	22.8	22.6	22.4	22.2
36							20.9	20.9	20.7	20.5	20.2
38								19.2	19	18.8	18.6
40								17.6	17.4	17.3	17
42									16.1	15.9	15.7
44										14.7	14.5
46											13.3
Parts of line	24	22	20	18	16	15	14	13	12	11	10

Note:

1.For areas with “**” , when boom length exceeds 74m, center hitch needs to be used; when boom length exceeds 77m, wedge needs to be used to assist boom raising.

1.1 Boom working condition _ boom main hook (without boom single top, HB/1)

Boom working condition _ boom main hook lifting capacity table (without boom single top, HB/1_75t+30t)

Working radius (m)	Boom length (m)										
	56	59	62	65	68	71	74	77*	80*	83*	86*
10	104.4	102	98.4								
11	94.7	92.6	90.6	88	78.8	71					
12	86.5	84.7	83	81.3	77.6	69.8	62.8	61.2	56		
13	79.5	77.9	76.4	74.9	73.4	68.7	61.8	60.4	55.3	50.8	46.6
14	73.5	72.1	70.7	69.3	68	66.8	60.7	59.5	54.6	50.1	46
15	68.2	66.9	65.7	64.5	63.2	62.2	59.7	58.7	53.8	49.4	45.4
16	63.6	62.4	61.3	60.2	59	58.1	57	56.1	53.1	48.9	44.8
17	59.5	58.4	57.4	56.3	55.3	54.4	53.3	52.6	51.6	48.1	44.2
18	55.8	54.8	53.9	52.9	51.9	51.1	50.1	49.4	48.5	47.5	43.6
19	52.1	51.6	50.7	49.8	48.9	48.1	47.2	46.6	45.7	44.9	43
20	48.5	48.3	47.8	47	46.1	45.4	44.6	44	43.1	42.4	41.6
22	42.3	42.1	41.9	41.7	41.3	40.7	39.9	39.4	38.7	38	37.3
24	37.4	37.2	37	36.7	36.5	36.4	36	35.5	34.9	34.3	33.6
26	33.3	33.1	32.9	32.7	32.4	32.3	32	32	31.6	31.1	30.4
28	29.9	29.7	29.5	29.2	29	28.9	28.6	28.6	28.3	28.2	27.7
30	27	26.8	26.6	26.3	26.1	25.9	25.7	25.6	25.4	25.2	25
32	24.5	24.3	24.1	23.8	23.6	23.4	23.2	23.1	22.9	22.7	22.4
34	22.3	22.1	21.9	21.6	21.4	21.3	21	21	20.7	20.5	20.3
36	20.4	20.2	20	19.7	19.5	19.3	19.1	19	18.8	18.6	18.3
38	18.7	18.5	18.3	18	17.8	17.6	17.4	17.3	17.1	16.9	16.6
40	17.2	17	16.8	16.5	16.3	16.1	15.9	15.8	15.6	15.4	15.1
42	15.9	15.6	15.4	15.2	14.9	14.8	14.5	14.5	14.2	14	13.8
44	14.7	14.4	14.2	14	13.7	13.6	13.3	13.2	13	12.8	12.5
46	13.6	13.3	13.1	12.8	12.6	12.4	12.2	12.1	11.9	11.7	11.4
48	12.5	12.3	12.1	11.8	11.6	11.4	11.2	11.1	10.9	10.7	10.4
50	11.6	11.4	11.2	10.9	10.6	10.5	10.2	10.2	9.9	9.8	9.5
52		10.5	10.3	10	9.8	9.7	9.4	9.4	9.1	8.9	8.6
54			9.5	9.3	9	8.9	8.6	8.6	8.3	8.1	7.9
56				8.5	8.3	8.1	7.9	7.8	7.6	7.4	7.1
58					7.8	7.6	7.5	7.2	7.2	6.9	6.5
60						7	6.8	6.6	6.5	6.3	6.1
62							6.2	6	5.9	5.7	5.5
64								6	5.9	5.7	5.5
66								5.4	5.4	5.1	5
68								4.9	4.9	4.6	4.5
70									4.4	4.1	4
72										3.7	3.5
74											3.2
76											2.8
Parts of line	9	9	8	7	7	6	5	5	5	4	4

Note:

1.For areas with “**” , when boom length exceeds 74m, center hitch needs to be used; when boom length exceeds 77m, wedge needs to be used to assist boom raising.

Typical Working Conditions

1.2 Boom working condition_boom main hook (with boom single top aux. hook, HBS/1)

Boom working condition_boom main hook working range (with boom single top, HBS/1)

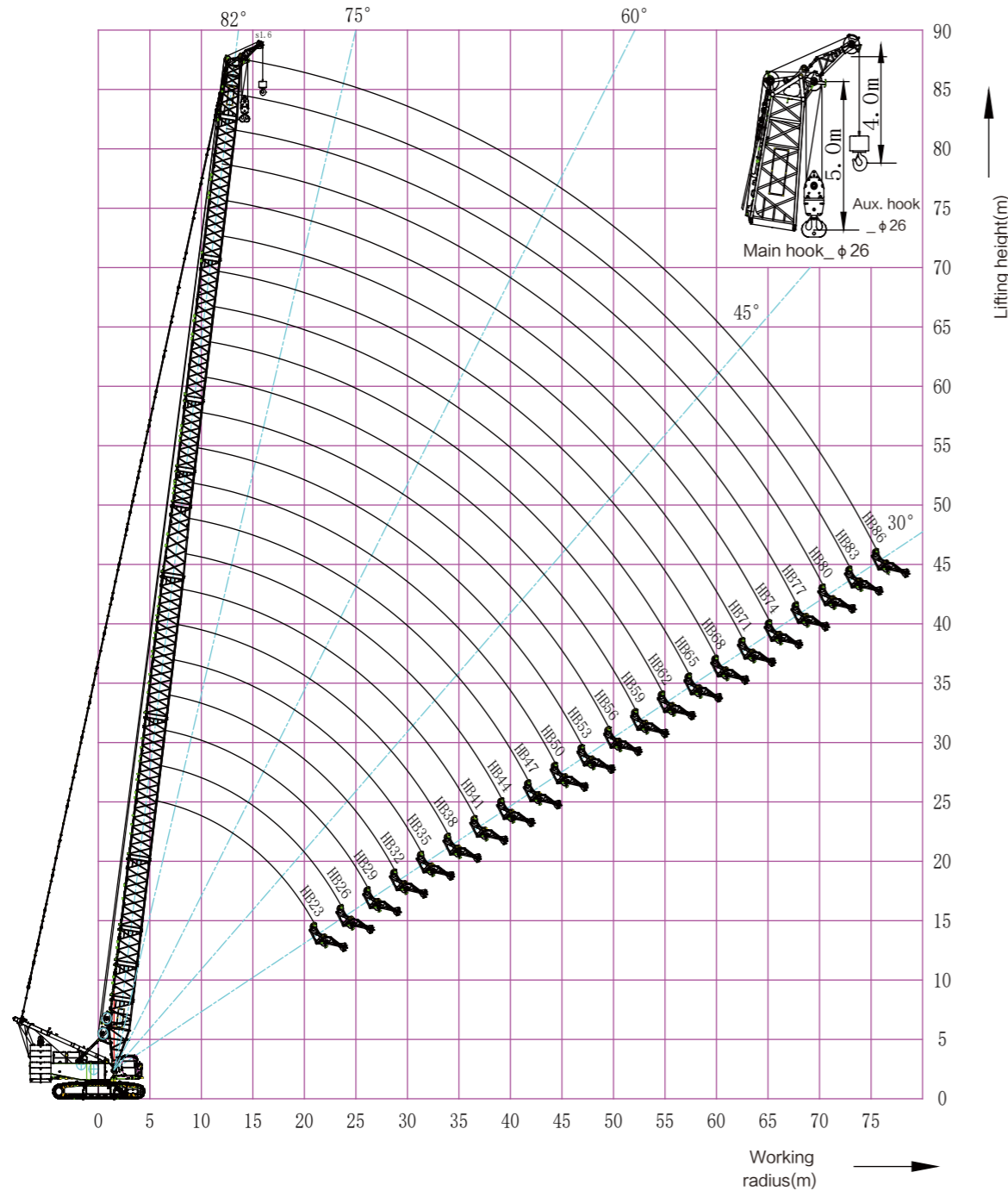

Boom working condition_boom main hook working range (with boom single top, HBS/1)

1.2 Boom working condition_boom main hook (with boom single top aux. hook, HBS/1)

Boom working condition _boom main hook lifting capacity table (with boom single top aux. hook, HBS/1_85t+30)

Working radius (m)	Boom length (m)											
	23	26	29	32	35	38	41	44	47	50	53	
5.5	260											
6	229.1	229.1	214.2									
7	189.4	189.4	189.2	189.3	183.9	172.9						
8	161	161	160.9	160.9	160.7	160.6	160.4	150.4				
9	139.8	139.8	139.6	139.7	139.5	139.3	139.1	137.3	133.7	127.2	126.9	
10	123.3	123.3	123.1	123.2	123	122.8	122.6	122.3	119.3	116.5	113.7	
11	110.1	110.1	109.9	110	109.8	109.6	109.4	109.3	107.6	105.2	102.8	
12	99.3	99.3	99.1	99.2	99	98.8	98.6	98.5	97.8	95.7	93.7	
13	90.3	90.3	90.1	90.2	90	89.8	89.6	89.5	89.2	87.7	85.9	
14	82.7	82.7	82.5	82.6	82.4	82.2	82	81.9	81.6	80.8	79.2	
15	76.2	76.3	76.1	76.1	75.9	75.7	75.4	75.4	75.1	74.8	73.4	
16	70.8	70.8	70.6	70.6	70.4	70.2	70	69.6	69.6	69.4	68.3	
17	65.4	65.5	65.4	65.5	65.4	65.3	65.2	65.1	64.8	64.6	63.8	
18	60.3	60.4	60.3	60.4	60.3	60.2	60.1	60	59.8	59.7	59.5	
19	55.8	56	55.9	56	55.9	55.8	55.6	55.5	55.4	55.2	55	
20	51.9	52	52	52.1	52	51.9	51.7	51.6	51.4	51.3	51.1	
22		45.5	45.4	45.5	45.4	45.3	45.1	45	44.8	44.7	44.5	
24		40.1	40.1	40.2	40.1	40	39.8	39.7	39.5	39.4	39.1	
26			35.7	35.8	35.7	35.6	35.4	35.4	35.2	35	34.8	
28				32.2	32	32	31.8	31.7	31.5	31.3	31.1	
30					28.9	28.8	28.7	28.6	28.4	28.2	28	
32					26.2	26.2	26	25.9	25.7	25.5	25.3	
34						23.8	23.6	23.6	23.4	23.2	23	
36							21.6	21.5	21.3	21.1	20.9	
38								19.7	19.5	19.3	19.1	
40								18.1	17.9	17.7	17.5	
42									16.4	16.2	16	
44										14.9	14.7	
46											13.5	
Parts of line	24	22	20	18	16	15	14	13	12	11	10	

Note:
 1. For areas with “**”, when boom length exceeds 74m, center hitch needs to be used; when boom length exceeds 77m, wedge needs to be used to assist boom raising.

Typical Working Conditions

1.2 Boom working condition_boom main hook (with boom single top aux. hook, HBS/1)

Boom working condition _boom main hook lifting capacity table (with boom single top aux. hook, HBS/1_85t+30)

Working radius (m)	Boom length (m)										
	56	59	62	65	68	71	74	77*	80*	83*	86*
10	111.4	108.2	98								
11	100.9	98.7	96.5	87.7	78.5	70.6					
12	92.1	90.1	88.3	86.3	77.2	69.4	62.5	60.3	55.2		
13	84.6	82.9	81.2	79.6	76	68.3	61.4	59.5	54.5	50	45.9
14	78.1	76.6	75.1	73.7	72.2	67.2	60.4	58.6	53.7	49.3	45.2
15	72.4	71.1	69.7	68.4	67.1	66	59.3	57.8	52.9	48.6	44.6
16	67.4	66.2	65	63.8	62.6	61.5	58.3	57	52.2	47.9	44
17	63	61.9	60.8	59.7	58.6	57.6	56.5	55.7	51.5	47.2	43.4
18	59.1	58	57	56	54.9	54.1	53.1	52.3	50.8	46.6	42.8
19	55.2	54.5	53.6	52.6	51.7	50.8	49.9	49.2	48.3	45.9	42.2
20	51.2	51	50.5	49.6	48.7	47.9	47.1	46.4	45.6	44.8	41.6
22	44.6	44.4	44.2	44	43.5	42.9	42.1	41.5	40.7	40.1	39.3
24	39.3	39.1	38.9	38.7	38.4	38.3	37.8	37.4	36.6	36	35.3
26	34.9	34.7	34.5	34.3	34	33.9	33.7	33.6	33.1	32.6	31.9
28	31.3	31	30.8	30.6	30.4	30.2	30	29.9	29.7	29.5	29
30	28.2	27.9	27.7	27.5	27.2	27.1	26.8	26.8	26.5	26.4	26.1
32	25.5	25.2	25	24.8	24.5	24.4	24.1	24.1	23.8	23.7	23.4
34	23.1	22.9	22.7	22.4	22.2	22.1	21.8	21.8	21.5	21.3	21.1
36	21.1	20.9	20.6	20.4	20.1	20	19.7	19.7	19.4	19.3	19
38	19.3	19	18.8	18.6	18.3	18.2	17.9	17.9	17.6	17.4	17.2
40	17.7	17.4	17.2	16.9	16.7	16.6	16.3	16.2	16	15.8	15.5
42	16.2	16	15.8	15.5	15.2	15.1	14.8	14.8	14.5	14.4	14.1
44	14.9	14.6	14.4	14.2	13.9	13.8	13.5	13.5	13.2	13	12.8
46	13.7	13.4	13.2	13	12.7	12.6	12.3	12.3	12	11.8	11.6
48	12.6	12.4	12.2	11.9	11.6	11.5	11.2	11.2	10.9	10.8	10.5
50	11.6	11.4	11.2	10.9	10.6	10.5	10.2	10.2	9.9	9.8	9.5
52		10.4	10.2	10	9.7	9.6	9.3	9.3	9	8.8	8.6
54			9.4	9.1	8.9	8.7	8.5	8.4	8.2	8	7.7
56				8.3	8.1	8	7.7	7.7	7.4	7.2	6.9
58				7.6	7.4	7.2	7	6.9	6.7	6.5	6.2
60					6.7	6.6	6.3	6.3	6	5.8	5.6
62						5.9	5.7	5.6	5.4	5.2	4.9
64							5.1	5	4.8	4.6	4.3
66							4.5	4.5	4.2	4.1	3.8
68								4	3.7	3.5	3.3
70									3.2	3	2.8
72										2.6	2.3
Parts of line	9	9	8	7	7	6	5	5	5	4	4

Note:
1.For areas with “**”, when boom length exceeds 74m, center hitch needs to be used; when boom length exceeds 77m, wedge needs to be used to assist boom raising.

1.2 Boom working condition_boom main hook (with boom single top aux. hook, HBS/1)

Boom working condition _boom main hook lifting capacity table (with boom single top aux. hook, HBS/1_75t+30)

Working radius (m)	Boom length (m)										
	23	26	29	32	35	38	41	44	47	50	53
5.5	242.8										
6	217.6	217.6	214.2								
7	179.8	179.8	179.7	179.7	179.5	171.4					
8	152.8	152.8	152.7	152.7	152.5	152.4	148.4	144			
9	132.6	132.6	132.5	132.5	132.3	132.2	130.1	126.6	123.2	120	116.9
10	116.9	116.9	116.8	116.8	116.6	116.5	115.5	112.7	109.9	107.3	104.7
11	104.4	104.4	104.2	104.2	104	103.9	103.7	101.4	99	96.8	94.6
12	94.1	94.1	93.9	94	93.8	93.6	93.4	92	90	88	86.1
13	85.6	85.6	85.4	85.4	85.2	85.1	84.8	84	82.3	80.6	78.9
14	78.6	78.6	78.4	78.4	78.2	78	77.8	77.3	75.7	74.2	72.7
15	71.9	72	72	72.1	72	71.9	71.8	71.4	70	68.7	67.3
16	65.5	65.6	65.6	65.6	65.5	65.5	65.3	65.2	65	63.8	62.6
17	60	60.1	60.1	60.2	60.1	60	59.8	59.7	59.6	59.4	58.4
18	55.3	55.4	55.3	55.4	55.3	55.2	55.1	55	54.8	54.7	54.5
19	51.1	51.3	51.2	51.3	51.2	51.1	50.9	50.9	50.7	50.5	50.3
20	47.5	47.7	47.6	47.7	47.6	47.5	47.3	47.2	47	46.9	46.7
22		41.5	41.5	41.6	41.5	41.4	41.2	41.1	40.9	40.8	40.6
24		36.6	36.6	36.7	36.6	36.5	36.3	36.2	36	35.8	35.6
26			32.5	32.6	32.5	32.4	32.2	32.2	32	31.8	31.6
28				29.2	29.1	29	28.8	28.8	28.5	28.4	28.1
30					26.2	26.1	25.9	25.9	25.7	25.5	25.2
32					23.7	23.6	23.4	23.4	23.2	23	22.8
34						21.4	21.2	21.2	21	20.8	20.6
36							19.3	19.3	19.1	18.9	18.7
38								17.6	17.4	17.2	17
40								16.1	15.9	15.7	15.5
42									14.5	14.4	14.1
44										13.1	12.9
46											11.8
Parts of line	24	22	20	18	16	15	14	13	12	11	10

Note:
1.For areas with “**”, when boom length exceeds 74m, center hitch needs to be used; when boom length exceeds 77m, wedge needs to be used to assist boom raising.

Typical Working Conditions

1.2 Boom working condition_boom main hook (with boom single top aux. hook, HBS/1)

Boom working condition _boom main hook lifting capacity table (with boom single top aux. hook, HBS/1_75t+30)

Working radius (m)	Boom length (m)									
	56	59	62	65	68	71	74	77*	80*	83*
10	102.5	100.2	97.8							
11	92.8	90.8	88.8	86.9	78.5	70.6				
12	84.7	82.9	81.1	79.4	77.2	69.4	62.5	60.3	55.2	
13	77.7	76.1	74.6	73.1	71.6	68.3	61.4	59.5	54.5	50
14	71.6	70.2	68.9	67.5	66.2	65	60.4	58.6	53.7	49.3
15	66.4	65.1	63.9	62.6	61.4	60.3	59.2	57.8	52.9	48.6
16	61.8	60.6	59.5	58.3	57.2	56.2	55.1	54.3	52.2	47.9
17	57.7	56.6	55.5	54.5	53.5	52.6	51.5	50.8	49.8	47.2
18	54	53	52	51.1	50.1	49.3	48.3	47.6	46.7	45.9
19	50.5	49.8	48.9	48	47.1	46.3	45.4	44.8	43.9	43.1
20	46.8	46.7	46	45.2	44.3	43.6	42.8	42.2	41.3	40.6
22	40.7	40.5	40.3	40.1	39.5	38.9	38.1	37.6	36.9	36.2
24	35.8	35.6	35.4	35.1	34.9	34.8	34.2	33.7	33.1	32.5
26	31.7	31.5	31.3	31.1	30.8	30.7	30.5	30.4	29.8	29.3
28	28.3	28.1	27.9	27.6	27.4	27.3	27	27	26.7	26.5
30	25.4	25.2	25	24.7	24.5	24.4	24.1	24.1	23.8	23.7
32	22.9	22.7	22.5	22.2	22	21.9	21.6	21.6	21.3	21.1
34	20.8	20.5	20.3	20.1	19.8	19.7	19.4	19.4	19.1	19
36	18.9	18.6	18.4	18.2	17.9	17.8	17.5	17.5	17.2	17
38	17.1	16.9	16.7	16.5	16.2	16.1	15.8	15.8	15.5	15.3
40	15.7	15.4	15.2	15	14.7	14.6	14.3	14.3	14	13.8
42	14.3	14.1	13.9	13.6	13.3	13.2	12.9	12.9	12.6	12.5
44	13.1	12.9	12.6	12.4	12.1	12	11.7	11.7	11.4	11.2
46	12	11.7	11.5	11.3	11	10.9	10.6	10.6	10.3	10.1
48	11	10.7	10.5	10.3	10	9.9	9.6	9.6	9.3	9.1
50	10	9.8	9.6	9.3	9.1	8.9	8.7	8.6	8.4	8.2
52		8.9	8.7	8.5	8.2	8.1	7.8	7.8	7.5	7.4
54			8	7.7	7.4	7.3	7	7	6.7	6.6
56				7	6.7	6.6	6.3	6.3	6	5.8
58				6.3	6	5.9	5.6	5.6	5.3	5.2
60					5.4	5.3	5	5	4.7	4.5
62						4.7	4.4	4.4	4.1	4
64							3.9	3.8	3.6	3.4
66							3.3	3.3	3.1	2.9
68								2.8	2.6	2.4
70									2.1	2
Parts of line	9	9	8	7	7	6	5	5	5	4

Note:
1. For areas with “*”, when boom length exceeds 74m, center hitch needs to be used; when boom length exceeds 77m, wedge needs to be used to assist boom raising.

1.3 Boom working condition_boom single top aux. hook (with boom main hook, HBS/2)

Boom working condition _boom single top aux. hook working range (with boom main hook, HBS/2)

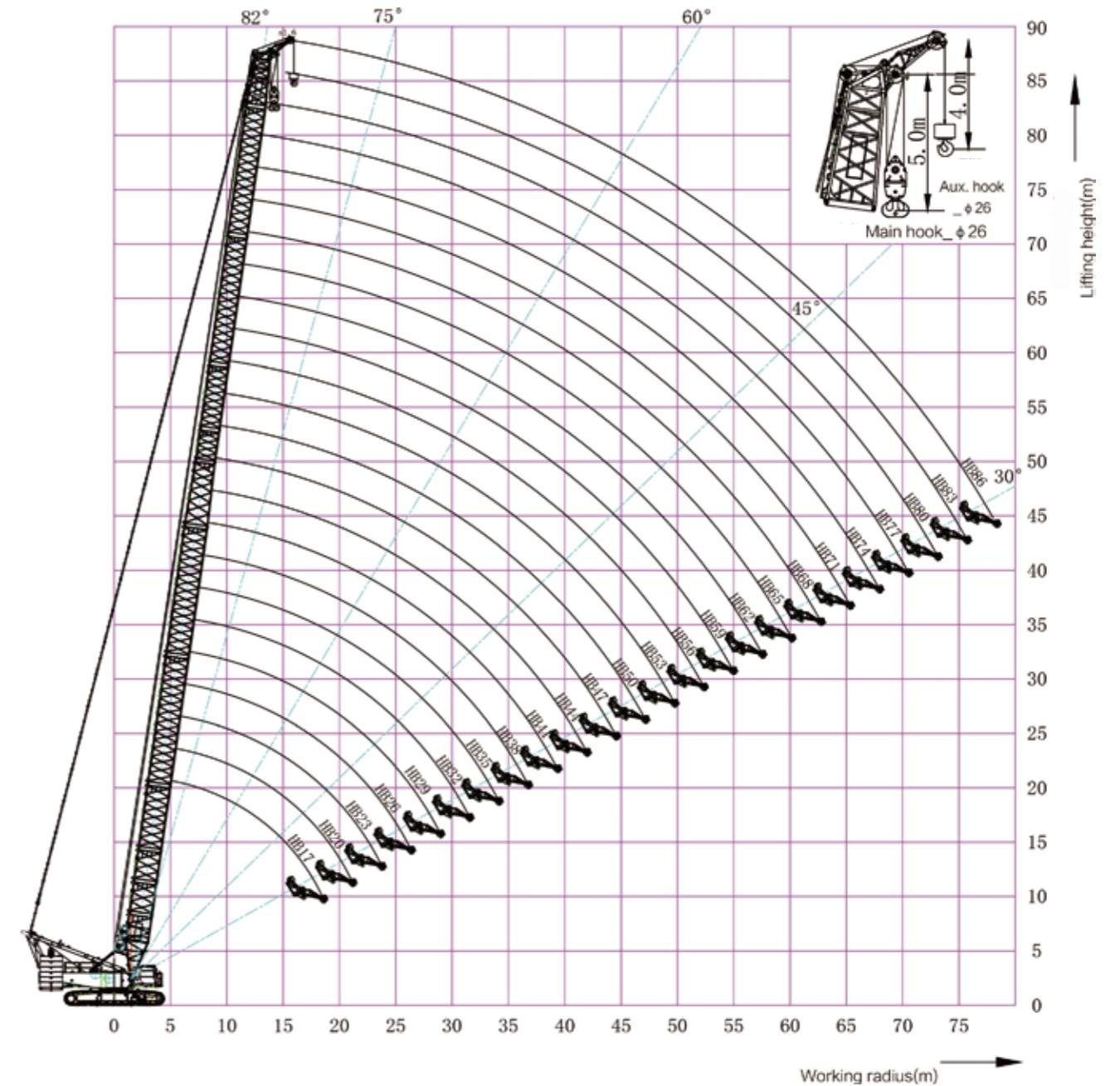

Boom working condition_boom single top aux. hook working range (with boom main hook, HBS/2)

Typical Working Conditions

1.3 Boom working condition_boom single top aux. hook (with boom main hook, HBS/2)

Boom working condition _ boom single top aux. hook lifting capacity table (with boom main hook, HBS/2_85t+30t)

Working radius (m)	Boom length (m)											
	23	26	29	32	35	38	41	44	47	50	53	
7	13.5	13.5										
8	13.5	13.5	13.5	13.5	13.5							
9	13.5	13.5	13.5	13.5	13.5	13.5	13.5					
10	13.5	13.5	13.5	13.5	13.5	13.5	13.5	13.5	13.5	13.5		
11	13.5	13.5	13.5	13.5	13.5	13.5	13.5	13.5	13.5	13.5	13.5	
12	13.5	13.5	13.5	13.5	13.5	13.5	13.5	13.5	13.5	13.5	13.5	
13	13.5	13.5	13.5	13.5	13.5	13.5	13.5	13.5	13.5	13.5	13.5	
14	13.5	13.5	13.5	13.5	13.5	13.5	13.5	13.5	13.5	13.5	13.5	
15	13.5	13.5	13.5	13.5	13.5	13.5	13.5	13.5	13.5	13.5	13.5	
16	13.5	13.5	13.5	13.5	13.5	13.5	13.5	13.5	13.5	13.5	13.5	
17	13.5	13.5	13.5	13.5	13.5	13.5	13.5	13.5	13.5	13.5	13.5	
18	13.5	13.5	13.5	13.5	13.5	13.5	13.5	13.5	13.5	13.5	13.5	
19	13.5	13.5	13.5	13.5	13.5	13.5	13.5	13.5	13.5	13.5	13.5	
20	13.5	13.5	13.5	13.5	13.5	13.5	13.5	13.5	13.5	13.5	13.5	
22	13.5	13.5	13.5	13.5	13.5	13.5	13.5	13.5	13.5	13.5	13.5	
24		13.5	13.5	13.5	13.5	13.5	13.5	13.5	13.5	13.5	13.5	
26		13.5	13.5	13.5	13.5	13.5	13.5	13.5	13.5	13.5	13.5	
28			13.5	13.5	13.5	13.5	13.5	13.5	13.5	13.5	13.5	
30				13.5	13.5	13.5	13.5	13.5	13.5	13.5	13.5	
32					13.5	13.5	13.5	13.5	13.5	13.5	13.5	
34					13.5	13.5	13.5	13.5	13.5	13.5	13.5	
36						13.5	13.5	13.5	13.5	13.5	13.5	
38							13.5	13.5	13.5	13.5	13.5	
40								13.5	13.5	13.5	13.5	
42									13.5	13.5	13.5	
44										13.5	13.5	
46											12.9	
48												11.6
Parts of line	1	1	1	1	1	1	1	1	1	1	1	1

Note:
1.For areas with “*”, when boom length exceeds 74m, center hitch needs to be used; when boom length exceeds 77m, wedge needs to be used to assist boom raising.

1.3 Boom working condition_boom single top aux. hook (with boom main hook, HBS/2)

Boom working condition _ boom single top aux. hook lifting capacity table (with boom main hook, HBS/2_85t+30t)

Working radius (m)	Boom length (m)											
	56	59	62	65	68	71	74	77*	80*	83*	86*	
11	13.5	13.5										
12	13.5	13.5	13.5	13.5	13.5							
13	13.5	13.5	13.5	13.5	13.5	13.5	13.5					
14	13.5	13.5	13.5	13.5	13.5	13.5	13.5	13.5	13.5	13.5		
15	13.5	13.5	13.5	13.5	13.5	13.5	13.5	13.5	13.5	13.5	13.5	
16	13.5	13.5	13.5	13.5	13.5	13.5	13.5	13.5	13.5	13.5	13.5	
17	13.5	13.5	13.5	13.5	13.5	13.5	13.5	13.5	13.5	13.5	13.5	
18	13.5	13.5	13.5	13.5	13.5	13.5	13.5	13.5	13.5	13.5	13.5	
19	13.5	13.5	13.5	13.5	13.5	13.5	13.5	13.5	13.5	13.5	13.5	
20	13.5	13.5	13.5	13.5	13.5	13.5	13.5	13.5	13.5	13.5	13.5	
22	13.5	13.5	13.5	13.5	13.5	13.5	13.5	13.5	13.5	13.5	13.5	
24	13.5	13.5	13.5	13.5	13.5	13.5	13.5	13.5	13.5	13.5	13.5	
26	13.5	13.5	13.5	13.5	13.5	13.5	13.5	13.5	13.5	13.5	13.5	
28	13.5	13.5	13.5	13.5	13.5	13.5	13.5	13.5	13.5	13.5	13.5	
30	13.5	13.5	13.5	13.5	13.5	13.5	13.5	13.5	13.5	13.5	13.5	
32	13.5	13.5	13.5	13.5	13.5	13.5	13.5	13.5	13.5	13.5	13.5	
34	13.5	13.5	13.5	13.5	13.5	13.5	13.5	13.5	13.5	13.5	13.5	
36	13.5	13.5	13.5	13.5	13.5	13.5	13.5	13.5	13.5	13.5	13.5	
38	13.5	13.5	13.5	13.5	13.5	13.5	13.5	13.5	13.5	13.5	13.5	
40	13.5	13.5	13.5	13.5	13.5	13.5	13.5	13.5	13.5	13.5	13.5	
42	13.5	13.5	13.5	13.5	13.5	13.5	13.5	13.5	13.5	13.5	13.5	
44	13.5	13.5	13.5	13.5	13.5	13.2	13.1	12.8	12.8	12.5	12.3	
46	12.9	12.7	12.5	12.2	12	11.9	11.6	11.6	11.3	11.1	10.9	
48	11.8	11.6	11.4	11.1	10.9	10.7	10.5	10.4	10.2	10	9.7	
50	10.8	10.5	10.4	10.1	9.9	9.7	9.5	9.4	9.2	9	8.7	
52	9.8	9.6	9.4	9.2	8.9	8.8	8.5	8.5	8.2	8.1	7.8	
54		8.7	8.5	8.3	8	7.9	7.7	7.6	7.4	7.2	6.9	
56			7.7	7.5	7.2	7.1	6.9	6.8	6.6	6.4	6.1	
58				6.7	6.5	6.4	6.1	6.1	5.8	5.7	5.4	
60					5.8	5.7	5.4	5.4	5.1	5	4.7	
62						5.1	5	4.8	4.7	4.5	4.3	
64							4.4	4.2	4.1	3.9	3.7	
66								3.6	3.6	3.3	3.2	
68									3	2.8	2.6	
70										2.3	2.1	
Parts of line	1	1	1	1	1	1	1	1	1	1	1	1

Note:
1.For areas with “*”, when boom length exceeds 74m, center hitch needs to be used; when boom length exceeds 77m, wedge needs to be used to assist boom raising.

Typical Working Conditions

2.4 Working radius of tower jib working condition (HW)

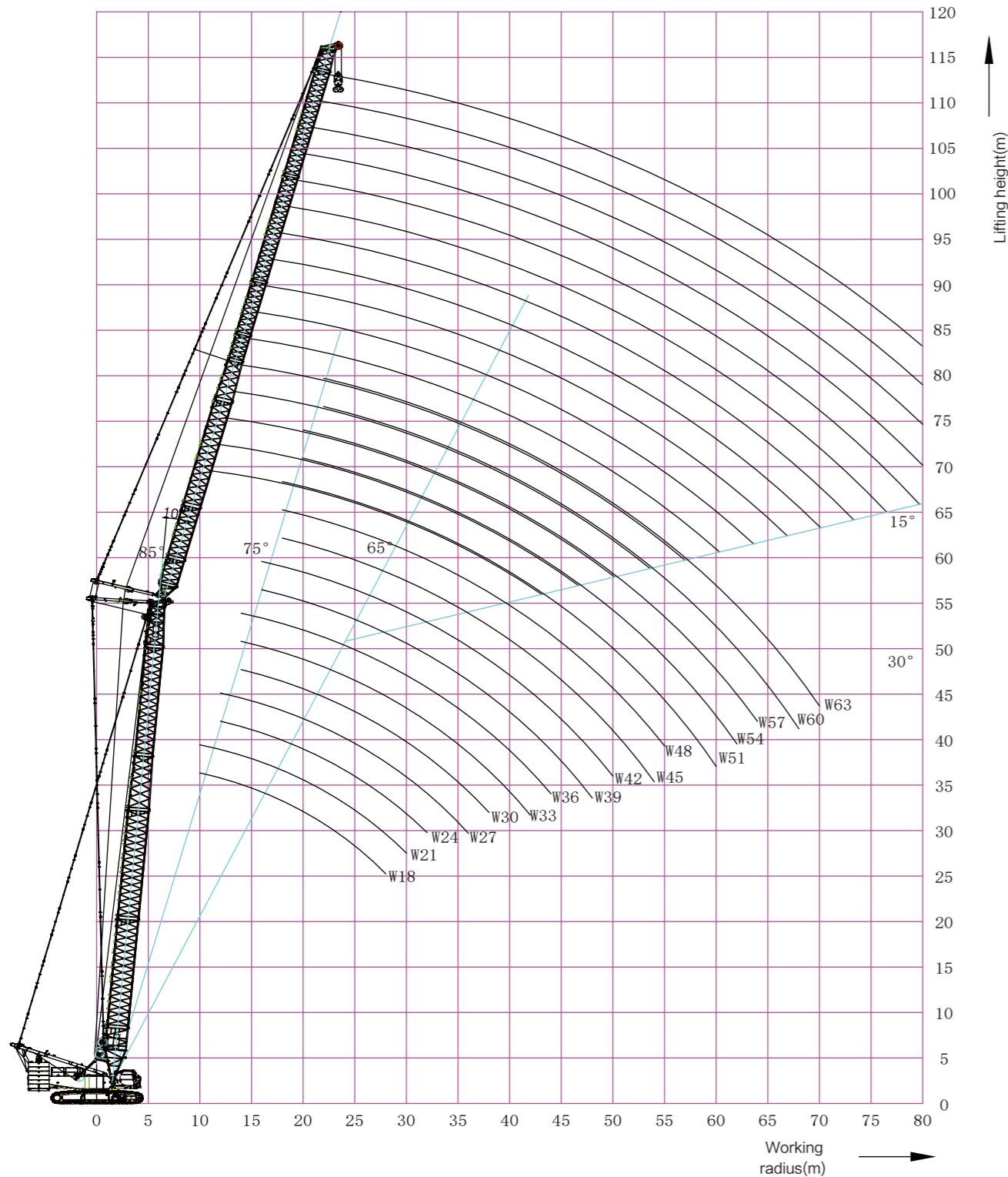

Working radius of tower jib working condition (HW)

2.5 Partial lifting performance of tower jib working condition (HW)

Notes:

1. The actual lifting weight is the remained weight after the weights of hook, slings and wire ropes reeved on hook and boom (jib) head are subtracted from the rated lifting load in table.
2. The rated loads in the table are the lifted values when the loads are lifted slowly and stably in non-travelling state on plane and solid ground with the gradient no more than 1%.
3. The load values given in the table are the load hanging freely without consideration of the influence of wind load to the lifted load, the ground condition, gradient, operation speed and nay other factors negatively impact on the safe operation of the crane. Thus, the operator is responsible for the current situation judgment, reducing the lifted load correspondingly and reducing the speed.
4. When tower jib length exceeds 48m, a center hitch must be used; When the combination length of the main boom and jib exceeds 71m, a wedge block is recommended to be used to raise the boom (jib).
5. No tower top single top working condition.

A. Main boom working angle is 85°

Typical Working Conditions

A. Main boom working angle is 85°

Radius/m	Boom Length23m, Boom Angle85° , Tower Jib Length/m																Radius/m
	18	21	24	27	30	33	36	39	42	45	48	51	54	57	60	63	
10	100																10
11	98.5	100															11
12	96.9	96.7	96.5														12
13	88.6	88.4	88.2	87.9													13
14	81.6	81.3	81.2	80.9	80.6												14
15	75.3	75.1	75.2	74.8	74.6	74.3											15
16	69.1	69	69	68.6	68.4	68.1	68.3	68.1									16
17	63.9	63.7	63.7	63.3	63.1	62.8	62.9	62.7	62.9								17
18	59.4	59.1	59.2	58.7	58.6	58.2	58.3	58	58.1	58							18
19	55.4	55.2	55.2	54.8	54.6	54.3	54.3	54	54.1	53.9	52.7						19
20	51.8	51.6	51.7	51.3	51.1	50.8	50.8	50.5	50.5	50.2	50.3	48					20
22		45.8	45.8	45.4	45.3	44.9	44.9	44.6	44.6	44.3	44.2	43.9	40.4	36.5			22
24		40.9	41	40.7	40.5	40.2	40.1	39.8	39.8	39.5	39.4	39	39	35.1	30.4	28.2	24
26			37.1	36.7	36.6	36.3	36.2	35.9	35.9	35.5	35.5	35.1	35	33.4	28.9	26.7	26
28				33.5	33.3	33	33	32.6	32.6	32.3	32.2	31.8	31.7	31.4	27.5	25.4	28
30				30.6	30.5	30.2	30.2	29.8	29.8	29.5	29.4	29	28.9	28.6	26.3	24.2	30
32				28.1	27.8	27.8	27.4	27.4	27.1	27	26.6	26.5	26.2	25.1	23.1		32
34					25.7	25.7	25.3	25.3	25	24.9	24.5	24.4	24.1	23.9	22.1		34
36					23.8	23.8	23.5	23.5	23.2	23	22.7	22.6	22.3	22.1	21.2		36
38						22.2	21.9	21.9	21.5	21.4	21	21	20.6	20.5	20.1		38
40							20.4	20.4	20.1	20	19.6	19.5	19.2	19	18.7		40
42								19.1	18.8	18.7	18.3	18.2	17.9	17.7	17.4		42
44								17.9	17.6	17.5	17.1	17	16.7	16.6	16.2		44
46									16.5	16.4	16.1	16	15.7	15.5	15.2		46
48										15.4	15.1	15	14.7	14.6	14.2		48
50										14.5	14.2	14.1	13.8	13.7	13.3		50
52											13.4	13.3	13	12.8	12.5		52
54												12.5	12.2	12.1	11.8		54
56													11.8	11.5	11.4	11.1	56
58														10.9	10.7	10.4	58
60															10.1	9.8	60
62															9.5	9.2	62
64																8.7	64
Countweight	85+30	85+30	85+30	85+30	85+30	85+30	85+30	85+30	85+30	85+30	85+30	85+30	85+30	85+30	85+30	85+30	Countweight
Parts of line	10	10	10	8	7	6	6	6	5	5	5	5	4	3	3	3	Parts of line

A. Main boom working angle is 85°

Radius/m	Boom Length26m, Boom Angle85° , Tower Jib Length/m																Radius/m
	18	21	24	27	30	33	36	39	42	45	48	51	54	57	60	63	
11	98.2																11
12	96.6	96.4	96.3														12
13	88.4	88.1	88	87.7													13
14	80.8	80.6	80.8	80.3	80.3												14
15	73.5	73.3	73.4	73	72.8	72.6											15
16	67.4	67.2	67.2	66.8	66.6	66.4	66.5										16
17	62.1	61.9	62	61.5	61.4	61.1	61.1	60.9									17
18	57.6	57.4	57.4	57	56.8	56.5	56.6	56.3	56.4	56.3							18
19	53.7	53.4	53.5	53.1	52.9	52.6	52.6	52.3	52.4	52.2	51.9						19
20	50.2	50	50.1	49.6	49.5	49.1	49.1	48.8	48.9	48.6	48.7	47.3					20
22		44.2	44.2	43.9	43.7	43.4	43.3	43	43	42.7	42.7	42.3	40	36.2			22
24		39.4	39.5	39.2	39.1	38.7	38.7	38.4	38.3	38	37.9	37.6	37.5	34.9	30.5	28.2	24
26			35.7	35.4	35.2	34.9	34.9	34.5	34.5	34.2	34.1	33.7	33.6	33.3	28.9	26.7	26
28				32.1	32	31.7	31.7	31.3	31.3	31	30.9	30.5	30.4	30.1	27.6	25.4	28
30				29.3	29.3	29	29	28.6	28.6	28.3	28.1	27.8	27.7	27.3	26.3	24.2	30
32					26.9	26.6	26.6	26.3	26.2	25.9	25.8	25.4	25.3	25	24.8	23.1	32
34						24.5	24.6	24.2	24.2	23.9	23.8	23.4	23.3	23	22.8	22.1	34
36						22.7	22.7	22.4	22.4	22.1	22	21.6	21.5	21.2	21	20.7	36
38								21.1	20.8	20.8	20.5	20.4	20	20	19.6	19.5	38
40										19.4	19.4	19.1	19	18.6	18.6	18.2	40
42											18.1	18.1	17.8	17.7	17.4	17.3	42
44												17	16.7	16.6	16.2	16.2	44
46													15.6	15.6	15.2	15.1	46
48														14.6	14.2	14.2	48
50															13.7	13.4	50
52																12.6	52
54																11.8	54
56																11.8	56
Countweight	85+30	85+30	85+30	85+30	85+30	85+30	85+30	85+30	85+30	85+30	85+30	85+30	85+30	85+30	85+30	85+30	Countweight
Parts of line	10	10	10	8	7	6	6	5	5	5	5	4	4	3	3	3	Parts of line

Typical Working Conditions

A. Main boom working angle is 85°

Radius/m	Boom Length 29m, Boom Angle 85°, Tower Jib Length/m																Radius/m		
	18	21	24	27	30	33	36	39	42	45	48	51	54	57	60	63			
11	97.9																11		
12	96.3	96.1															12		
13	88.1	87.9	87.7														13		
14	80	79.8	80	79.6	79.5												14		
15	72.6	72.4	72.5	72.1	71.9	71.8											15		
16	66.4	66.2	66.2	65.8	65.7	65.4	65.5										16		
17	61.1	61	61	60.6	60.4	60.1	60.2	60									17		
18	56.6	56.4	56.5	56	55.9	55.6	55.6	55.3	55.4								18		
19	52.7	52.5	52.5	52.1	51.9	51.6	51.6	51.3	51.4	51.2							19		
20	49.2	49	49.1	48.7	48.5	48.2	48.2	47.8	47.9	47.6	47.7	46.4					20		
22	43.2	43.2	43.3	42.9	42.8	42.4	42.4	42.1	42.1	41.8	41.7	41.4	39.5	35.8			22		
24		38.5	38.6	38.3	38.2	37.8	37.8	37.4	37.4	37.1	37	36.7	36.6	34.6	30.5	28.2	24		
26			34.8	34.5	34.4	34	34	33.6	33.6	33.3	33.2	32.8	32.8	32.4	29	26.8	26		
28				31.3	31.2	30.9	30.8	30.5	30.5	30.1	30	29.6	29.6	29.2	27.6	25.4	28		
30				28.5	28.5	28.2	28.2	27.8	27.8	27.5	27.3	27	26.9	26.5	26.3	24.3	30		
32					26.1	25.9	25.8	25.5	25.5	25.1	25	24.7	24.6	24.2	24.1	23.2	32		
34						23.8	23.8	23.5	23.5	23.2	23	22.7	22.6	22.2	22.1	21.7	34		
36						22	22.1	21.7	21.7	21.4	21.3	20.9	20.8	20.5	20.3	20	36		
38							20.5	20.2	20.2	19.8	19.7	19.4	19.3	19	18.8	18.5	38		
40								18.8	18.8	18.5	18.4	18	17.9	17.6	17.4	17.1	40		
42									17.5	17.5	17.2	17.1	16.7	16.7	16.3	16.2	15.9	42	
44										16.4	16.1	16	15.6	15.6	15.2	15.1	14.8	44	
46											15	15	14.6	14.6	14.2	14.1	13.8	46	
48											14.1	14	13.7	13.6	13.3	13.2	12.8	48	
50												13.2	12.8	12.8	12.5	12.3	12	50	
52													12	12	11.7	11.6	11.2	52	
54														11.3	11.3	11	10.8	10.5	54
Countweight	85+30	85+30	85+30	85+30	85+30	85+30	85+30	85+30	85+30	85+30	85+30	85+30	85+30	85+30	85+30	85+30	Countweight		
Parts of line	10	10	8	7	7	6	6	5	5	5	4	4	4	4	3	3	3	Parts of line	

A. Main boom working angle is 85°

Radius/m	Boom Length 32m, Boom Angle 85°, Tower Jib Length/m																Radius/m					
	18	21	24	27	30	33	36	39	42	45	48	51	54	57	60	63						
11	97.7																11					
12	96.1	95.8															12					
13	87.9	87.6	87.5														13					
14	80.3	80.2	80.3	79.9													14					
15	72.7	72.5	72.6	72.2	72.1												15					
16	66.4	66.2	66.2	65.8	65.6	65.4	65.5										16					
17	61	60.8	60.9	60.4	60.3	60	60	59.8									17					
18	56.4	56.2	56.2	55.8	55.7	55.3	55.4	55.1	55.2								18					
19	52.4	52.3	52.3	51.9	51.7	51.4	51.3	51	51.1	50.9							19					
20	48.9	48.8	48.8	48.4	48.2	47.9	47.8	47.5	47.6	47.3	47.4						20					
22	42.9	42.9	43	42.6	42.4	42.1	42	41.7	41.7	41.4	41.4	41	38.9	35.3			22					
24		38.2	38.3	37.9	37.8	37.4	37.4	37.1	37	36.7	36.6	36.3	36.2	34.2	30.4	28	24					
26			34.4	34.1	34	33.7	33.6	33.3	33.3	32.9	32.8	32.4	32.3	32	29	26.8	26					
28				31.1	30.9	30.8	30.5	30.5	30.1	30.1	29.7	29.6	29.2	29.2	28.8	27.6	25.5	28				
30					28.2	28.1	27.8	27.8	27.4	27.4	27.1	27	26.6	26.5	26.1	26	24.3	30				
32						25.8	25.5	25.5	25.1	25.1	24.8	24.7	24.3	24.2	23.8	23.7	23.2	32				
34							23.7	23.5	23.5	23.1	23.1	22.8	22.7	22.3	22.2	21.9	21.7	21.3	34			
36								21.6	21.7	21.4	21.4	21	20.9	20.6	20.5	20.1	20	19.6	36			
38									20.1	19.8	19.8	19.5	19.4	19	18.9	18.6	18.4	18.1	38			
40										18.4	18.4	18.1	18	17.6	17.6	17.2	17.1	16.7	40			
42											17.1	17.2	16.9	16.8	16.4	16.3	16	15.9	15.5	42		
44												16	15.8	15.7	15.3	15.2	14.9	14.8	14.4	44		
46													14.7	14.7	14.3	14.2	13.9	13.8	13.4	46		
48														13.8	13.7	13.4	13.3	13	12.9	12.5	48	
50															12.9	12.5	12.5	12.2	12	11.7	50	
52																11.7	11.7	11.4	11.3	10.9	52	
54																	11	11	10.7	10.6	10.2	54
Countweight	85+30	85+30	85+30	85+30	85+30	85+30	85+30	85+30	85+30	85+30	85+30	85+30	85+30	85+30	85+30	85+30	85+30	Countweight				
Parts of line	10	10	8	7	6	6	5	5	5	4	4	4	4	3	3	3	3	3	3	3	Parts of line	

Typical Working Conditions

A. Main boom working angle is 85°

Radius/m	Boom Length35m, Boom Angle85° , Tower Jib Length/m																Radius/m
	18	21	24	27	30	33	36	39	42	45	48	51	54	57	60	63	
12	95.8	95.5															12
13	87.6	87.3	87.1														13
14	80.6	80.4	80.2	79.9													14
15	73	72.8	72.8	72.4	72.3												15
16	66.4	66.2	66.3	65.9	65.7	65.5											16
17	61	60.8	60.8	60.4	60.2	59.9	60										17
18	56.3	56.1	56.1	55.7	55.5	55.2	55.2	55	55.1								18
19	52.2	52.1	52.1	51.7	51.5	51.2	51.1	50.8	50.9	50.7							19
20	48.7	48.5	48.6	48.2	48	47.6	47.6	47.3	47.3	47.1	46.5						20
22	42.7	42.6	42.7	42.3	42.2	41.8	41.8	41.4	41.4	41.1	41	40.7	38.3				22
24		37.9	38	37.6	37.5	37.1	37.1	36.7	36.7	36.4	36.3	35.9	35.9	33.7	30.1	27.6	24
26			34.1	33.8	33.7	33.3	33.3	32.9	32.9	32.6	32.5	32.1	32	31.7	29	26.7	26
28			30.8	30.6	30.5	30.2	30.1	29.8	29.8	29.4	29.3	28.9	28.8	28.5	27.6	25.5	28
30				27.8	27.8	27.5	27.5	27.1	27.1	26.7	26.6	26.2	26.1	25.8	25.6	24.3	30
32					25.4	25.2	25.2	24.8	24.8	24.4	24.3	23.9	23.9	23.5	23.3	23	32
34					23.4	23.1	23.1	22.8	22.8	22.5	22.3	22	21.9	21.5	21.4	21	34
36						21.3	21.4	21.1	21.1	20.7	20.6	20.2	20.1	19.8	19.6	19.3	36
38							19.8	19.5	19.5	19.2	19.1	18.7	18.6	18.3	18.1	17.8	38
40							18.4	18.1	18.1	17.8	17.7	17.3	17.3	16.9	16.8	16.4	40
42								16.9	16.9	16.6	16.5	16.1	16	15.7	15.6	15.2	42
44									15.8	15.5	15.4	15	14.9	14.6	14.5	14.1	44
46										14.5	14.4	14	14	13.6	13.5	13.2	46
48										13.5	13.5	13.1	13	12.7	12.6	12.3	48
50											12.6	12.3	12.2	11.9	11.8	11.4	50
52												11.5	11.5	11.1	11	10.7	52
54													10.8	10.7	10.4	10.3	54
56														10.1	9.8	9.7	56
Countweight	85+30	85+30	85+30	85+30	85+30	85+30	85+30	85+30	85+30	85+30	85+30	85+30	85+30	85+30	85+30	85+30	Countweight
Parts of line	10	9	8	7	6	6	5	5	5	4	4	4	3	3	3	3	Parts of line

A. Main boom working angle is 85°

Radius/m	Boom Length38m, Boom Angle85° , Tower Jib Length/m																Radius/m
	18	21	24	27	30	33	36	39	42	45	48	51	54	57	60	63	
12	95.5																12
13	87.3	87															13
14	80.4	80.1	80	78.5													14
15	73.7	73.5	73.6	73.1	72.1												15
16	67	66.8	66.8	66.4	66.2	66											16
17	61.4	61.2	61.2	60.8	60.6	60.3	60.3										17
18	56.6	56.4	56.4	56	55.8	55.5	55.5	55.2									18
19	52.5	52.3	52.3	51.9	51.7	51.3	51.3	51	51.1								19
20	48.8	48.7	48.7	48.3	48.1	47.7	47.7	47.4	47.4	47.2	44.3						20
22	42.7	42.7	42.7	42.3	42.2	41.8	41.8	41.4	41.4	41.1	41	39.9	37.3				22
24		37.9	38	37.6	37.5	37.1	37.1	36.7	36.7	36.3	36.2	35.8	35.7	33.2	29.7		24
26			34.1	33.7	33.6	33.3	33.2	32.9	32.8	32.5	32.4	32	31.9	31.6	28.7	26.4	26
28			30.7	30.5	30.4	30.1	30	29.7	29.6	29.3	29.2	28.8	28.7	28.3	27.6	25.5	28
30				27.7	27.7	27.4	27.3	27	27	26.6	26.5	26.1	26	25.6	25.5	24.3	30
32					25.3	25	25	24.7	24.7	24.3	24.2	23.8	23.7	23.3	23.2	22.8	32
34					23.2	23	23	22.7	22.7	22.3	22.2	21.8	21.7	21.4	21.2	20.8	34
36						21.2	21.2	20.9	20.9	20.6	20.5	20.1	20	19.6	19.5	19.1	36
38							19.7	19.4	19.4	19	18.9	18.5	18.5	18.1	18	17.6	38
40							18.2	18	18	17.7	17.6	17.2	17.1	16.8	16.6	16.3	40
42								16.7	16.8	16.4	16.3	16	15.9	15.5	15.4	15.1	42
44									15.6	15.3	15.2	14.9	14.8	14.5	14.3	14	44
46									14.6	14.3	14.2	13.9	13.8	13.5	13.3	13	46
48										13.4	13.3	13	12.9	12.6	12.4	12.1	48
50											12.5	12.1	12.1	11.7	11.6	11.3	50
52													11.4	11.3	11	10.9	52
54														10.6	10.6	10.3	54
56															9.9	9.6	56
Countweight	85+30	85+30	85+30	85+30	85+30	85+30	85+30	85+30	85+30	85+30	85+30	85+30	85+30	85+30	85+30	85+30	Countweight
Parts of line	10	9	8	7	6	6	5	5	5	4	4	4	3	3	3	3	Parts of line

Typical Working Conditions

A. Main boom working angle is 85°

Radius/m	Boom Length41m, Boom Angle85° , Tower Jib Length/m																Radius/m
	18	21	24	27	30	33	36	39	42	45	48	51	54	57	60	63	
12	94.4																12
13	86.9	85.7															13
14	80	79.8	78.4														14
15	74.1	73.9	73.5	72													15
16	67.7	67.5	67.5	67	66.5	65.2											16
17	61.9	61.7	61.7	61.2	61.1	60.8	60.3										17
18	57	56.8	56.8	56.3	56.1	55.8	55.8	54.5									18
19	52.8	52.5	52.6	52.1	51.9	51.6	51.5	51.3	49.6								19
20	49.1	48.9	48.9	48.5	48.3	47.9	47.9	47.5	47.6	44.9							20
22	42.9	42.8	42.8	42.4	42.2	41.9	41.8	41.5	41.4	41.1	39.9	37.7	35.3				22
24		37.9	38	37.6	37.5	37.1	37	36.7	36.6	36.3	36.2	35.8	33.8	31.6	29.2		24
26		33.8	34	33.7	33.6	33.2	33.2	32.8	32.8	32.4	32.3	31.9	31.8	30.3	28.3	26.1	26
28			30.7	30.4	30.3	30	30	29.6	29.6	29.2	29.1	28.7	28.6	28.2	27.3	25.2	28
30				27.7	27.6	27.3	27.2	26.9	26.9	26.5	26.4	26	25.9	25.5	25.3	24.3	30
32					25.2	24.9	24.9	24.6	24.5	24.2	24.1	23.7	23.6	23.2	23	22.7	32
34					23.1	22.9	22.9	22.6	22.5	22.2	22.1	21.7	21.6	21.2	21.1	20.7	34
36						21.1	21.1	20.8	20.8	20.5	20.3	19.9	19.9	19.5	19.3	19	36
38							19.6	19.3	19.3	18.9	18.8	18.4	18.3	18	17.8	17.5	38
40							18.1	17.9	17.9	17.5	17.4	17	17	16.6	16.5	16.1	40
42								16.6	16.6	16.3	16.2	15.8	15.8	15.4	15.3	14.9	42
44									15.5	15.2	15.1	14.7	14.7	14.3	14.2	13.8	44
46									14.5	14.2	14.1	13.7	13.7	13.3	13.2	12.8	46
48										13.3	13.2	12.8	12.8	12.4	12.3	12	48
50											12.4	12	11.9	11.6	11.5	11.1	50
52												11.6	11.2	11.2	10.9	10.7	52
54													10.5	10.5	10.2	10	54
56														9.8	9.5	9.4	56
Countweight	85+30	85+30	85+30	85+30	85+30	85+30	85+30	85+30	85+30	85+30	85+30	85+30	85+30	85+30	85+30	85+30	Countweight
Parts of line	9	8	7	6	6	6	5	5	4	4	4	4	3	3	3	3	Parts of line

A. Main boom working angle is 85°

Radius/m	Boom Length44m, Boom Angle85° , Tower Jib Length/m																Radius/m
	18	21	24	27	30	33	36	39	42	45	48	51	54	57	60	63	
12	92.2																12
13	85.5	83.8															13
14	79.8	78.2	76.8														14
15	73.9	73.3	72	70.6													15
16	68.8	68.5	67.8	66.4	65.2												16
17	62.8	62.5	62.5	62.1	61.6	60.5	56.9										17
18	57.7	57.5	57.4	57	56.8	56.5	55.1	51.5									18
19	53.3	53.1	53.1	52.7	52.5	52.1	52.1	50	46.9								19
20	49.5	49.3	49.4	48.9	48.7	48.3	48.3	48	45.7	42.7							20
22	43.2	43.1	43.2	42.7	42.5	42.2	42.1	41.7	41.7	40.4	38	35.9					22
24		38.1	38.2	37.9	37.7	37.3	37.2	36.9	36.8	36.5	36	34.2	32.3	30.2	28.3		24
26		34	34.2	33.9	33.7	33.4	33.3	32.9	32.9	32.5	32.4	32	30.7	28.9	27.3	25.5	26
28			30.8	30.6	30.5	30.1	30.1	29.7	29.6	29.3	29.1	28.7	28.6	27.6	26.1	24.5	28
30				27.8	27.7	27.3	27.3	27	26.9	26.5	26.4	26	25.9	25.5	24.9	23.5	30
32				25.3	25.3	25	25	24.6	24.6	24.2	24.1	23.7	23.6	23.2	23	22.4	32
34					23.2	22.9	22.9	22.6	22.6	22.2	22.1	21.7	21.6	21.2	21	20.7	34
36						21.1	21.1	20.8	20.8	20.4	20.3	19.9	19.8	19.5	19.3	18.9	36
38							19.6	19.3	19.2	18.9	18.8	18.4	18.3	17.9	17.8	17.4	38
40								18.1	17.8	17.9	17.5	17.4	17	16.9	16.6	16.4	40
42									16.6	16.6	16.3	16.2	15.8	15.7	15.4	15.2	42
44										15.5	15.2	15.1	14.7	14.6	14.3	14.1	44
46											14.4	14.2	14.1	13.7	13.6	13.3	46
48												13.2	13.2	12.8	12.7	12.4	48
50													12.3	12	11.9	11.6	50
52														11.5	11.2	11.1	52
54															10.5	10.4	54
56																9.8	56
Countweight	85+30	85+30	85+30	85+30	85+30	85+30	85+30	85+30	85+30	85+30	85+30	85+30	85+30	85+30	85+30	85+30	Countweight
Parts of line	8	7	7	6	6	5	5	5	4	4	3	3	3	3	3	2	Parts of line

Typical Working Conditions

A. Main boom working angle is 85°

Radius/m	Boom Length 47m, Boom Angle 85°, Tower Jib Length/m																Radius/m	
	18	21	24	27	30	33	36	39	42	45	48	51	54	57	60	63		
13	83.7	82															13	
14	78.1	76.6	75.2														14	
15	73.2	71.8	70.6	69.1													15	
16	68.5	67.6	66.5	65.2	62.8												16	
17	63.5	63.3	62.8	61.6	60.4	56.8											17	
18	58.3	58	58	57.6	57.3	54.8	51.7										18	
19	53.8	53.6	53.6	53.1	52.9	52.6	50	47	44.2								19	
20	49.9	49.7	49.7	49.3	49.1	48.7	48.2	45.5	43	40.2							20	
22	43.5	43.4	43.4	43	42.8	42.4	42.3	41.9	40.4	38.1	35.9	33.9					22	
24		38.3	38.4	38	37.8	37.4	37.4	37	37	35.8	34	32.3	30.5	28.6			24	
26		34.1	34.3	34	33.8	33.4	33.4	33	33	32.6	32	30.6	29.1	27.4	25.9	24.2	26	
28			30.9	30.6	30.5	30.1	30.1	29.7	29.7	29.3	29.2	28.8	27.5	26.1	24.7	23.3	28	
30				27.8	27.7	27.4	27.3	27	26.9	26.5	26.4	26	25.9	24.7	23.5	22.2	30	
32				25.3	25.3	25	25	24.6	24.6	24.2	24.1	23.6	23.5	23.2	22.3	21.2	32	
34					23.2	22.9	22.9	22.6	22.5	22.2	22	21.6	21.5	21.2	21	20.1	34	
36						21.1	21.1	20.8	20.8	20.4	20.3	19.9	19.8	19.4	19.2	18.9	36	
38						19.4	19.5	19.2	19.2	18.8	18.7	18.3	18.2	17.9	17.7	17.3	38	
40							18.1	17.8	17.8	17.5	17.4	17	16.9	16.5	16.4	16	40	
42								16.5	16.6	16.2	16.1	15.7	15.6	15.3	15.1	14.8	42	
44								15.3	15.4	15.1	15	14.6	14.5	14.2	14	13.7	44	
46									14.4	14.1	14	13.6	13.6	13.2	13.1	12.7	46	
48										13.2	13.1	12.7	12.6	12.3	12.2	11.8	48	
50											12.2	11.9	11.8	11.5	11.3	11	50	
52											11.4	11.1	11.1	10.7	10.6	10.3	52	
54												10.4	10.3	10	9.9	9.6	54	
56													9.7	9.4	9.3	8.9	56	
58														9.1	8.8	8.7	8.3	58
Countweight	85+30	85+30	85+30	85+30	85+30	85+30	85+30	85+30	85+30	85+30	85+30	85+30	85+30	85+30	85+30	85+30	Countweight	
Parts of line	8	7	7	6	6	5	5	4	4	4	3	3	3	3	3	2	Parts of line	

A. Main boom working angle is 85°

Radius/m	Boom Length 50m, Boom Angle 85°, Tower Jib Length/m																Radius/m
	18	21	24	27	30	33	36	39	42	45	48	51	54	57	60	63	
13	81.2																13
14	76.5	74.2															14
15	71.7	70.3	68.2	64.8													15
16	67.5	66.3	65.1	62.5	58.9												16
17	63.8	62.6	61.6	60.1	56.8	53.4											17
18	59.1	58.9	58.4	57.3	54.7	51.6	48.7										18
19	54.5	54.3	54.2	53.8	52.5	49.7	47.2	44.3									19
20	50.5	50.3	50.3	49.8	49.6	47.9	45.6	43	40.6								20
22	43.9	43.8	43.8	43.4	43.2	42.8	42.3	40.2	38.3	36.1	34.1	32.2					22
24	38.5	38.6	38.7	38.3	38.1	37.7	37.6	37.2	35.8	34	32.3	30.7	29	27.2			24
26		34.4	34.5	34.2	34	33.6	33.6	33.2	33.1	31.9	30.4	29.1	27.6	26.1	24.6	23.1	26
28			31.1	30.8	30.7	30.3	30.2	29.9	29.8	29.4	28.6	27.4	26.2	24.8	23.6	22.2	28
30				27.9	27.8	27.5	27.4	27.1	27	26.6	26.5	25.7	24.7	23.5	22.4	21.2	30
32				25.4	25.4	25.1	25	24.7	24.6	24.3	24.1	23.7	23.3	22.2	21.3	20.2	32
34					23.3	23	23	22.6	22.6	22.2	22.1	21.7	21.6	20.9	20.1	19.2	34
36						21.1	21.2	20.8	20.8	20.4	20.3	19.9	19.8	19.4	19	18.2	36
38						19.5	19.6	19.2	19.2	18.9	18.7	18.3	18.2	17.9	17.7	17.2	38
40							18.1	17.8	17.8	17.5	17.4	17	16.9	16.5	16.3	16	40
42								16.5	16.6	16.2	16.1	15.7	15.6	15.3	15.1	14.8	42
44								15.3	15.4	15.1	15	14.6	14.5	14.2	13.9	13.5	44
46									14.4	14.1	14	13.6	13.6	13.2	13	12.6	46
48										13.2	13.1	12.7	12.6	12.3	12.1	11.8	48
50											12.2	11.9	11.8	11.5	11.3	10.9	50
52											11.4	11.1	11.1	10.7	10.6	10.2	52
54												10.4	10.3	10	9.9	9.5	54
56													9.7	9.4	9.2	8.9	56
58														9.3	9.2	8.9	58
Countweight	85+30	85+30	85+30	85+30	85+30	85+30	85+30	85+30	85+30	85+30	85+30	85+30	85+30	85+30	85+30	85+30	Countweight
Parts of line	7	6	6	6	5	5	4	4	4	3	3	3	3	3	2	2	Parts of line

Typical Working Conditions

A. Main boom working angle is 85°

Radius/m	Boom Length53m, Boom Angle85° , Tower Jib Length/m																Radius/m
	18	21	24	27	30	33	36	39	42	45	48	51	54	57	60	63	
13	76.4																13
14	73.6	69.9															14
15	70.2	67.4	64.2														15
16	66.2	64.9	61.9	58.4													16
17	62.6	61.4	59.2	56.2	53.1	50											17
18	59.3	58.2	56.6	53.9	51.2	48.3	45.7										18
19	55.2	54.9	53.9	51.5	49.2	46.6	44.3	41.6									19
20	51.1	50.9	50.8	49.2	47.2	44.9	42.8	40.4	38.3								20
22	44.3	44.2	44.2	43.7	43.2	41.4	39.8	37.8	36.1	34	32.2						22
24	38.9	38.9	39	38.6	38.4	38	36.7	35.2	33.8	32.1	30.5	29	27.5	25.8			24
26		34.6	34.8	34.4	34.2	33.8	33.8	32.6	31.4	30	28.7	27.4	26.1	24.7	23.4	21.9	26
28			31.3	30.9	30.8	30.4	30.4	30	29.2	28	27	25.8	24.8	23.5	22.3	21	28
30			28.2	28	27.9	27.6	27.5	27.1	27	26	25.2	24.3	23.3	22.2	21.2	20.1	30
32				25.5	25.5	25.1	25.1	24.7	24.7	24.1	23.5	22.7	22	21	20.1	19.1	32
34					23.3	23	23	22.7	22.6	22.2	21.8	21.2	20.6	19.8	19	18.1	34
36						21.2	21.2	20.8	20.8	20.5	20.2	19.7	19.2	18.6	17.9	17.2	36
38							19.5	19.6	19.2	19.2	18.9	18.7	18.3	18	17.4	16.9	38
40								18	17.8	17.8	17.5	17.4	17	16.7	16.3	15.8	40
42									16.4	16.4	16.2	16.1	15.7	15.6	15.2	14.8	42
44										15	15.1	14.9	14.9	14.6	14.5	14.2	44
46											13.9	13.8	13.7	13.6	13.5	13.2	46
48												12.7	12.7	12.6	12.5	12.3	48
50													11.7	11.7	11.6	11.4	50
52														10.9	10.8	10.8	52
54															10	10	54
56																9.3	56
58																	58
Countweight	85+30	85+30	85+30	85+30	85+30	85+30	85+30	85+30	85+30	85+30	85+30	85+30	85+30	85+30	85+30	85+30	Countweight
Parts of line	7	6	6	5	5	4	4	4	3	3	3	3	3	2	2	2	Parts of line

A. Main boom working angle is 85°

Radius/m	Boom Length56m, Boom Angle85° , Tower Jib Length/m																Radius/m
	18	21	24	27	30	33	36	39	42	45	48	51	54	57	60	63	
13	66.9																13
14	63.9	60.8															14
15	58.8	58.7	55.6														15
16	54.5	54.4	53.9	51.1													16
17	50.8	50.7	50.7	49.3	46.6												17
18	47.6	47.4	47.4	47.2	45	42.4											18
19	44.7	44.5	44.5	44.3	43.3	40.9	38.8	36.5									19
20	42.2	42	42	41.7	41.5	39.5	37.6	35.4	33.6								20
22	37.8	37.7	37.6	37.4	37.3	36.5	35	33.2	31.7	29.9	28.3						22
24	34.3	34.1	34.1	33.9	33.7	33.5	32.3	30.9	29.7	28.2	26.8	25.4	24.1				24
26		31.2	31.1	30.9	30.8	30.6	29.8	28.6	27.6	26.4	25.2	24.1	22.9	21.6	20.5	19.2	26
28			28.7	28.4	28.3	28	27.3	26.4	25.6	24.6	23.7	22.7	21.7	20.6	19.6	18.4	28
30				26.5	26.3	26	25.5	25	24.3	23.7	22.9	22.1	21.3	20.5	19.5	18.6	30
32					23.9	23.6	23.2	22.9	22.3	21.9	21.2	20.6	19.9	19.2	18.4	17.6	32
34						21.4	21.1	20.9	20.4	20.1	19.6	19.1	18.5	18	17.3	16.6	34
36							19.4	19.2	19	18.7	18.5	18.1	17.7	17.2	16.8	16.2	36
38								17.4	17.4	17.2	17	16.7	16.4	16	15.7	15.2	38
40									15.9	15.7	15.6	15.4	15.2	14.9	14.6	14.2	40
42											14.4	14.4	14.2	14	13.8	13.6	42
44												13.2	13.2	13	13	12.7	44
46													12.1	12	12	11.8	46
48														11.1	11.1	10.9	48
50															10.2	10.2	50
52																9.4	52
54																	54
56																	56
58																	58
Countweight	85+30	85+30	85+30	85+30	85+30	85+30	85+30	85+30	85+30	85+30	85+30	85+30	85+30	85+30	85+30	85+30	Countweight
Parts of line	6	5	5	5	4	4	4	3	3	3	3	2	2	2	2	2	Parts of line

Transport parameters of main components

39

XLC260 CRAWLER CRANE

P40-P46 Transport parameters of main components

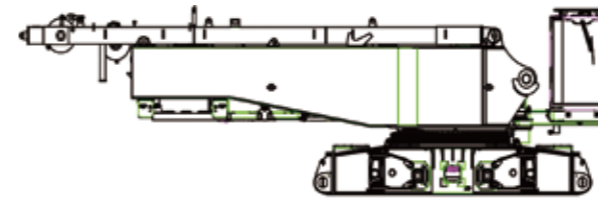

Basic machine transport plan A		× 1
L	12.60 m	
W	3.00 m	
H	3.30 m	
W	42.2 t	

Include main luffing winch and rope, cab, mast, pulley block and etc. Not include optional parts such as turntable counterweight self-assembly device, tower jib single top winch

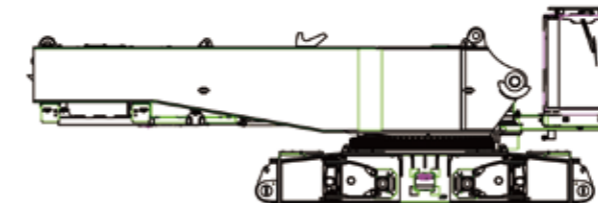

Basic machine transport plan B		× 1
L	10.7 m	
W	3.00 m	
H	3.30 m	
W	35.4 t	

Not include main luffing winch and rope, mast, luffing pulley block, turntable counterweight self-assembly device, tower jib single top winch and etc.



Mast separate transport parts (optional)		× 1
L	9.98 m	
W	1.94 m	
H	1.32 m	
W	6.8 t	

Include main luffing winch and rope, mast, luffing pulley block and some boom pendants, it is used when not transported with basic machine



Left track frame		× 1
L	9.33 m	
W	1.45 m	
H	1.38 m	
W	22.5 t	

Include hydraulic oil circuit

Transport parameters of main components



Right track frame	× 1
L	9.33 m
W	1.45 m
H	1.38 m
W	22.5 t

Include hydraulic oil circuit

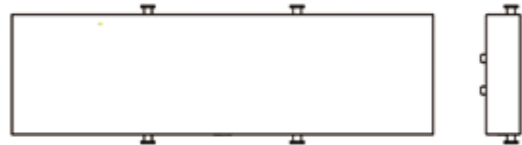

Car-body counterweight block	× 2
L	5.60 m
W	1.69 m
H	0.72 m
W	15 t

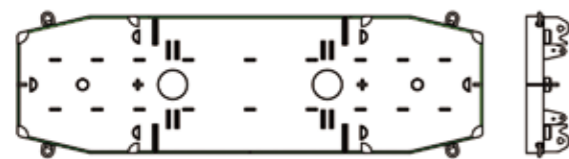

Turntable counterweight tray	× 1
L	7.3 m
W	2.62 m
H	0.61 m
W	15.0 t

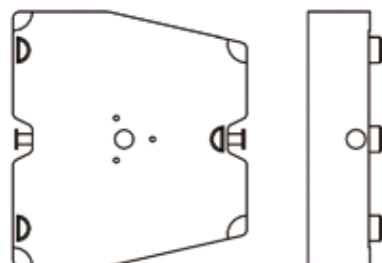

Turntable counterweight block	× 14
L	2.1 m
W	2.38 m
H	0.4 m
W	5.0 t

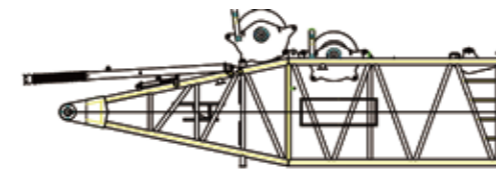

Boom butt	× 1
L	9.98 m
W	2.96 m
H	3.3 m
W	11.8 t

Include main winch, aux. winch and ropes, boom pendant, tower jib pendant, backstop device and etc.

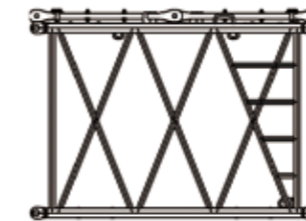

Boom insert 3mA	× 1
L	3.17 m
W	2.5 m
H	2.36 m
W	1.1 t

Include boom and tower jib pendants

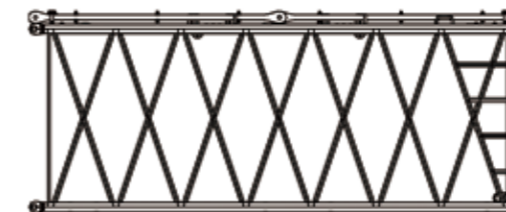

Boom insert 6mA	× 1
L	6.17 m
W	2.5 m
H	2.36 m
W	1.8 t

Include boom and tower jib pendants



Boom insert 12mA	× 2
L	12.18 m
W	2.5 m
H	2.36 m
W	3.1 t

Include boom and tower jib pendants

Transport parameters of main components

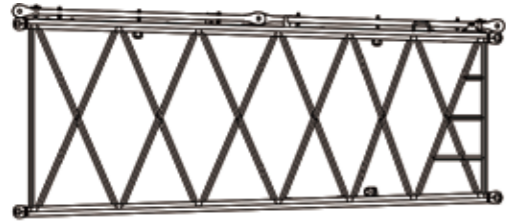

6m boom transition section	× 1
L	6.17 m
W	2.5 m
H	2.36 m
W	1.7 t

Include boom and tower jib pendants

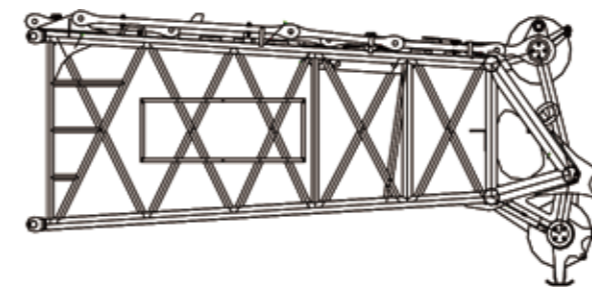

Boom top	× 1
L	5.58 m
W	2.2 m
H	2.47 m
W	3.7 t

Include boom and tower jib pendants

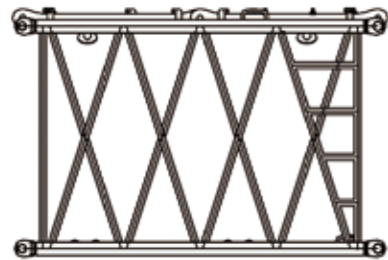

Boom insert 3mB	× 2
L	3.13 m
W	2.12 m
H	1.89 m
W	0.75 t

Include boom and tower jib pendants

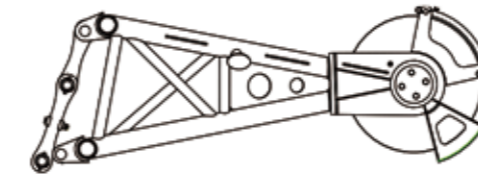

Tower jib four-piece set	× 1
L	2.065 m
W	1.16 m
H	0.7 m
W	0.26 t

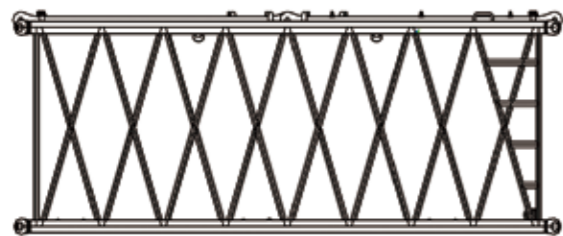

Boom insert 6mB	× 1
L	6.13 m
W	2.12 m
H	1.89 m
W	1.3 t

Include boom and tower jib pendants

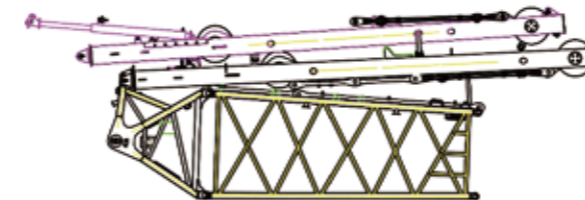

Tower jib four-piece set	× 1
L	9.66 m
W	2.4 m
H	3.19 m
W	6.0 t

Include tower jib butt, transition section, front strut, rear strut, pendant, backstop device and etc.

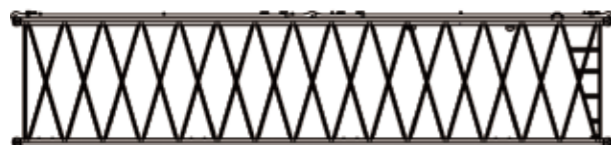

Boom insert 12mB	× 2
L	5.58 m
W	2.2 m
H	2.47 m
W	3.7 t

Include boom and tower jib pendants

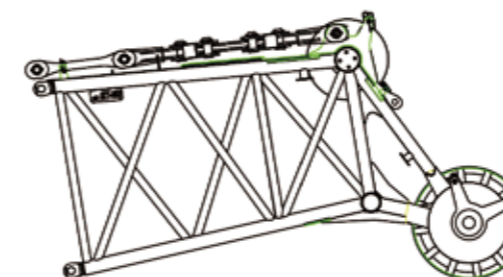

Boom insert 12mA	× 1
L	3.75 m
W	1.99 m
H	1.99 m
W	1.6 t

Include pendant

Transport parameters of main components

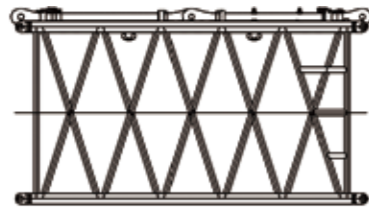

Tower jib insert 3mC	× 1
L	3.17 m
W	1.79 m
H	1.59 m
W	0.6 t

Include pendant

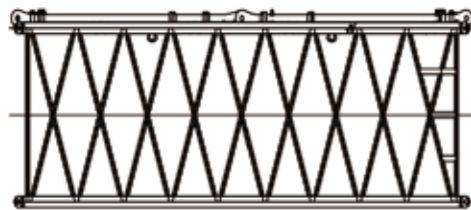

Tower jib insert 6mC	× 1
L	6.17 m
W	1.79 m
H	1.59 m
W	1.1 t

Include pendant

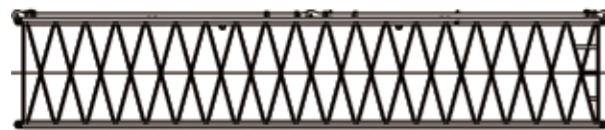

Tower jib insert 12mC	× 2
L	12.17 m
W	1.79 m
H	1.59 m
W	2.0 t

Include pendant

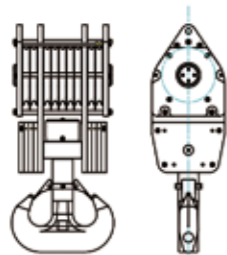

160t capacity hook block	× 1
L	1.07 m
W	1.07 m
H	2.35 m
W	4.6 t

Optional

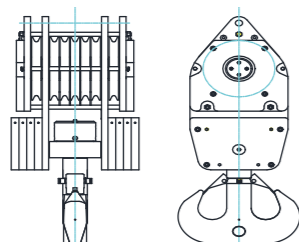

200t capacity hook block	× 1
L	0.99 m
W	0.94 m
H	2.24 m
W	4.20 t

Optional

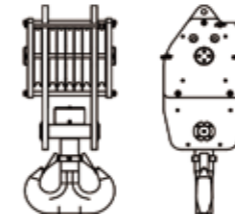

13.5t capacity hook block	× 1
L	0.866 m
W	0.76 m
H	2.35 m
W	2.20 t

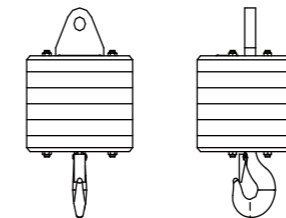

260t capacity hook block	× 1
L	0.485 m
W	0.485 m
H	0.787 m
W	0.50 t

Notes:

- 1.The parts which are not listed above include clips, small size pin shafts, bolts, several small pendants or sling connectors, and etc., total weight is not more than 3t.
- 2.Slight difference is ineluctable during product manufacture, and dimension and weight of some parts are variable due to continuous improvement in products.
- 3.Various pendants are easy confused, so before transportation, customers should make marks on corresponding pendants to avoid unnecessary troubles.